



Air-Conditioning, Heating, and Refrigeration
Institute (AHRI) Low-GWP Alternative Refrigerants
Evaluation Program (Low-GWP AREP)

TEST REPORT #33

Compressor Calorimeter Test of R-410A Alternative: R-32/R-134a Mixture Using a Scroll Compressor

Som Shrestha,
Vishaldeep Sharma,
Omar Abdelaziz

Oak Ridge National Laboratory
Oak Ridge, TN 3783

February 18, 2014

**This report has been made available to the public
as part of the author company's participation in the
AHRI's Low-GWP AREP.**



Air-Conditioning, Heating, and Refrigeration Institute
2111 Wilson Boulevard, Suite 500
Arlington VA 22201
(703) 524-8800
www.ahrinet.org

List of Tested Refrigerant's Composition (Mass%)

R-32/R-134a	R-32/R-134a (94.07/5.93)
-------------	--------------------------

DISCLAIMER

This report was prepared as an account of work sponsored by an agency of the United States Government. Neither the United States Government nor any agency thereof, nor any of their employees, makes any warranty, express or implied, or assumes any legal liability or responsibility for the accuracy, completeness, or usefulness of any information, apparatus, product, or process disclosed, or represents that its use would not infringe privately owned rights. Reference herein to any specific commercial product, process, or service by trade name, trademark, manufacturer, or otherwise, does not necessarily constitute or imply its endorsement, recommendation, or favoring by the United States Government or any agency thereof. The views and opinions of authors expressed herein do not necessarily state or reflect those of the United States Government or any agency thereof.

Table of Contents

Abstract	4
1. Introduction	4
2. Test Setup	5
a. Description of Test Refrigerant and Lubricant.....	5
b. Description of the Compressor	5
c. Description of the Compressor Calorimeter Test Loop	6
d. Test Description	7
3. Results	7
Acknowledgements.....	8
References	9
Appendix A: Tabular Data	10
Appendix B: Performance Maps	17
Capacity, Input Power, and EER	17
10-Coefficient polynomial equation for each test refrigerant	21

Abstract

As a contribution to the AHRI Low-GWP Alternative Refrigerants Evaluation Program (AREP), this study compares the performance of a scroll compressor with a lower-GWP alternative refrigerant R-32 + R-134a mixture vs. that with refrigerant R-410A (baseline). These comparisons were carried out via compressor calorimeter tests performed on an air-conditioning/heat pump compressor designed for refrigerant R-410A and having a nominal rated capacity of 21,300 Btu/hr.

Tests were conducted over a suction dew point temperature range of 10°F to 55°F in 5°F increments and a discharge dew point temperature range of 70°F to 140°F in 10°F increments. All the tests were performed with 20°F superheat, 40°F superheat, and 65°F suction temperature. A liquid subcooling level of 15°F was maintained for all the test conditions.

The tests showed that the discharge temperature of the alternative refrigerant was higher than that of R-410A at all test conditions. Also, the energy efficiency ratio (EER) and cooling capacity of the compressor with the alternative refrigerant were slightly lower compared to those with R-410A.

1. Introduction

This report investigates the tested performance of lower-GWP candidate refrigerant, 94.07 wt% R-32 + 5.93 wt% R-134a mixture (hereafter referred to as R-32/134a), as an alternative to baseline refrigerant R-410A using a 36,000 Btu/hr compressor calorimeter located at the Heat Exchanger Advanced Testing Facility at Oak Ridge National Laboratory. These tests were conducted during May and August 2013.

R-410A is a near-azeotropic blend of R-32 and R-125 with 0.5/0.5 mass fraction and has a GWP_{100} of 2100. R-32 and R-134a are pure refrigerants and have GWP_{100} of 716 and 1370¹, respectively. Based on the GWP_{100} values of pure refrigerants and their mass fraction in the blend, GWP_{100} of R-32/134a, which is under development by National Refrigerant, is 755.

This report compares various performance parameters, such as cooling capacity, compressor power, refrigerant mass flow rate, EER, isentropic efficiency and discharge temperature of the alternative refrigerant to that of R-410A.

¹ The GWPs given for R-410A, R-32, and R-134a are the latest scientific assessment values for a 100 year ITH (integration time horizon) given in the "2010 Report of the refrigeration, air conditioning and heat pumps technical options committee; Chapter 2, Refrigerants." United Nations Environment Programme (UNEP) Ozone Secretariat, Nairobi, Kenya, <http://ozone.unep.org/teap/Reports/RTOC/RTOC-Assessment-report-2010.pdf>.

2. Test Setup

a. Description of Test Refrigerant and Lubricant

- Refrigerant or refrigerant blend tested
 - R-410A: R-32 and R-125 blend with 0.5/0.5 mass fraction
 - R-32 + R-134a mixture with 0.9407/0.0593 mass fraction
- Lubricant
 - The lubricant used for all the tests is the original lubricant charged in the scroll compressor - 25 oz of polyolester oil (POE).

b. Description of the Compressor

The compressor used for this test was a Copeland scroll compressor ZP21K5E-PFV that has a 3/4" suction port and a 1/2" discharge port. This hermetic compressor uses a 208/230 volt, single phase, 60 Hz electric motor. Displacement volume of the compressor is 1.24 in³/rev or 150.69 ft³/hr. Table 1 shows the rated performance of the compressor at standard test conditions.

Table 1. Manufacturer's Rated Performance Data for the Test Compressor

Evap (°F) / Cond (°F)	45 / 130	50 / 100
RG (°F) / Liq (°F)	65 / 115	70 / 85
Capacity (Btu/hr)	21300	29000
Power (Watts)	2170	1400
Current (Amps)	9.50	6.30
EER (Btu/Wh)	9.80	20.60
Mass Flow (lbs/hr)	314	357

No modification to the compressor or the lubricant was made for the tests documented in this report. The compressor was uninsulated and airflow to the compressor chamber was maintained by two small fans, circulating air from outlets about 1.5 ft above the compressor. Combined airflow rate of the two fans was 750 cfm. The compressor chamber air temperature was maintained at 95±1°F for all the tests.

To ensure the accuracy of the test set-up and the data acquisition hardware and the software, the measured performance of the test compressor with the baseline R-410A refrigerant was compared with the compressor map data provided by the compressor manufacturer. This confirmed that the test data are in good agreement with the data provided by compressor manufacturer. At standard test conditions (evaporating/condensing temperature 45°F/130°F and 50°F/100°F), calculated EER and capacity from the test data are within ±4% and ±1.5%, respectively, of the compressor manufacturer's data. This is well within the ±5% tolerance allowed in ANSI/AHRI 540-2004 for capacity and efficiency.

c. Description of the Compressor Calorimeter Test Loop

The compressor calorimeter test loop, shown in Figure 1, consists of a test compressor, a condenser, a sub-cooler, three electronic expansion valves, and an evaporator. Suction pressure, suction temperature, liquid temperature, compressor chamber air temperature, and discharge pressure are controlled independently by controlling the electronic expansion valve, evaporator heater output, secondary glycol temperature, heating or cooling the air within the compressor chamber, and temperature of the condenser, respectively. Figure 1 also shows the location of the various sensors in the compressor calorimeter test loop. Temperature is measured using RTDs inserted in the tubes. Suction and discharge temperature sensors are located at about four feet from compressor. All tubes are insulated using Armaflex insulation. Table 2 lists the accuracy of the test instruments used in the calorimeter.

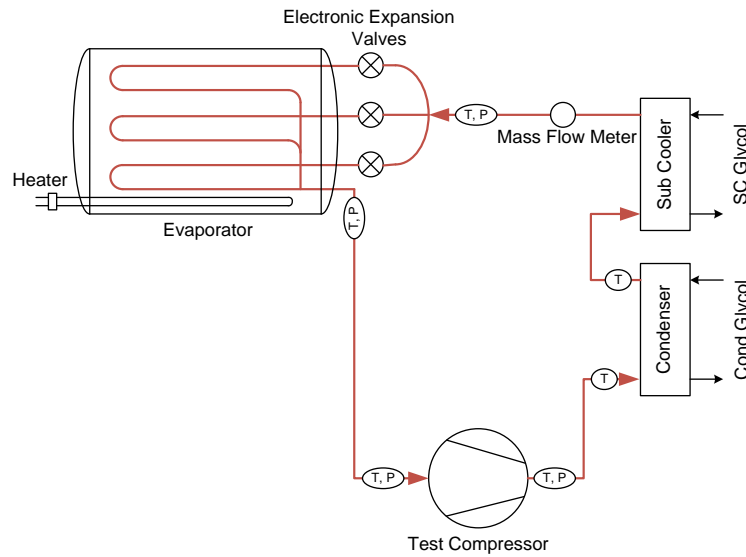

Figure 1 Schematic of the compressor calorimeter test loop.

Table 2. Accuracy of the Instruments used in the Compressor Calorimeter Test Loop

Instrument	Measured Parameter	Measurement Range	Accuracy
RTDs	Temperature	-94 to 932°F	± 0.4°F
Micro Motion Elite® Sensor	Refrigerant mass flow rate	0 to 1000 lb/hr	±0.10%
Yokogawa Power and Energy Meter PR300	Compressor power	0 to 5750 kVA at 230V	±0.5%
Honeywell Pressure Transmitter 060-F444-02	Refrigerant pressure, high pressure side	0 to 750 psia	0.25% F.S.
Honeywell Pressure Transmitter 060-F443-05	Refrigerant pressure, low pressure side	0 to 200 psia	0.25% F.S.

d. Test Description

The compressor calorimetry was performed according to ANSI/ASHRAE Standard 23.1-2010. Tests were conducted over a wide range of operating conditions. The suction dew point temperature was varied between 10°F and 55°F in 5°F increments while the discharge dew point temperature was varied between 70°F and 140°F in 10°F increments. These tests were performed with 15°F subcooling and either 20°F or 40°F superheat. Tests were also conducted at a fixed 65°F suction temperature. Steady state conditions for saturated suction temperature, suction temperature, saturated discharge temperature, and expansion valve inlet temperature were specified as setpoint temperature $\pm 0.5^\circ\text{F}$.

For compressor safety, the maximum discharge temperature was set at 275°F for all tests. Therefore, a refrigerant with higher discharge temperatures (R-32/134a in this case) yielded a lower number of test data points compared to the refrigerant with lower discharge temperatures (R-410A in this case). Conditions with lower suction dew point temperature and higher discharge dew point temperature combinations could not be tested due to the limit on discharge temperature.

3. Results

Appendix A provides summary results of all the tests conducted for this study in a tabular form. Appendix B provides 10-coefficient polynomial equations for mass flow, capacity, power, EER and discharge temperature computed from the test results for each test refrigerant at standard rating conditions of 20°F superheat and 15°F subcooling. Appendix B also presents figures showing capacity, input power, EER, and isentropic efficiency as a function of suction dew point temperature for given discharge dew point temperature at 20°F superheat and 15°F subcooling for R-410A and R-32/134a. The isentropic efficiency plots show the trends in compressor performance independent of the system performance. The properties of R-410A and R-32/134a mixture were calculated using REFPROP version 9.0 (Lemmon et al, 2010).

Table 3 shows differences in EER, capacity, and discharge temperature of the alternative refrigerant compared to that of R-410A at 15°F subcooling, 20°F superheat, 70°F to 140°F saturated discharge temperature and 10°F to 55°F saturated suction temperature. The table also shows the differences in performance parameters at two standard test conditions.

After completion of tests reported in AREP report number 11 (Shrestha et al., 2013), suction and discharge pressure measurement taps were moved about three feet towards the compressor suction and discharge ports, respectively. This modification was made to improve the compressor evaluation accuracy by avoiding additional pressure drop in connecting lines. As a result of this modification, the baseline compressor performance prediction showed slight improvement over previously reported values: at standard test

conditions, Evap 45°F/ Cond 130°F and Evap 50°F/ Cond 100°F, EER with R-410A changed from 9.90 to 10.18 and 20.62 to 21.42, respectively.

Table 3. Performance of R-32/134a compared to that of R-410A

Refrigerant	Test Condition	Deviation from baseline (R-410A)		
		EER	Capacity	Discharge Temperature
R-32/134a	Evap 45°F/ Cond 130°F	-2.2%	-0.8%	+37°F
	Evap 50°F/ Cond 100°F	-4.3%	-2.8	+22°F
	Over the range	-5.2% to -1.4%	-4.9% to +0.3%	+16 to +50°F

Figure 2 presents the ratio of EER_{alt} and $EER_{Baseline}$ as a function of suction dew point temperature for given discharge dew point temperature at 20°F superheat and 15°F subcooling. At all test conditions, the EER with R-32/134a was lower than that with R-410A (by 1.4 to 5.2%). At higher discharge dew point temperatures, the ratio generally increased as the suction dew point temperature increased. The opposite trend can be seen at lower discharge dew point temperatures.

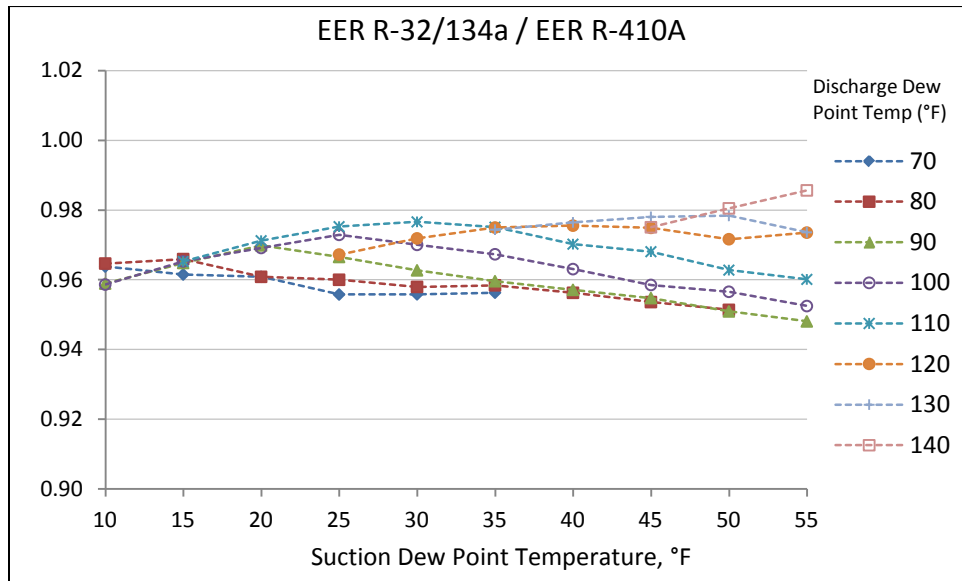

Figure 2 Compressor EER with R-32/134a compared to that with R-410A.

Acknowledgements

This work was supported by the Building Technologies Office of the U. S. Department of Energy under Contract No. DE-AC05-00OR22725 with UT-Battelle, LLC. The authors would like to acknowledge the contributions of Brian Goins and Randall Linkous for their technical support.

References

ANSI/AHRI 540-2004, *Standard for Performance Rating of Positive Displacement Refrigerant Compressors and Compressor Units*

ANSI/ASHRAE Standard 23.1-2010, *Methods of Testing for Rating the Performance of Positive Displacement Refrigerant Compressors and Condensing Units that Operate at Subcritical Temperatures of the Refrigerant*

Lemmon, E.W. Huber, M.L., and McLinden, M. O., 2010, *NIST Standard Reference Database 23, NIST Reference Fluid Thermodynamic and Transport Properties—REFPROP. Version 9.0 User's Guide*, November 2010

Shrestha, S., Mahderekal, I., Sharma, V., and Abdelaziz, O., 2013. *Compressor Calorimeter Test of R-410A Alternatives R-32, DR-5, And L-41a*. Air-Conditioning, Heating, and Refrigeration Institute Low-GWP Alternative Refrigerants Evaluation Program, Test Report #11

Appendix A

Tabular Data

The tables which follow provide summary data of all tests conducted for this study. Applicable superheat and subcooling levels for each test are provided in each table heading. Performance parameters such as cooling capacity, compressor power, compressor current, refrigerant mass flow rate, EER, isentropic efficiency, and discharge temperature are tabulated as a function of discharge dew point temperature and suction dew point temperature for fixed degree of superheat or fixed suction temperature. Since EER values are provided, COP values are not included in these tables. For easy comparisons, performance parameters at standard rating conditions are written in bold and underlined fonts.

Table A1: R-410A at 20°F Superheat, 15°F Subcooling

		Suction Dew Point Temp, °F (Suction Pressure, psia)									
		10 (76)	15 (84)	20 (93)	25 (102)	30 (111)	35 (122)	40 (133)	45 (144)	50 (157)	55 (170)
Discharge Dew Point Temp, °F (Discharge Pressure, psia)	140 (556)						15419	17361	19402	21574	23884
	C						2428	2413	2399	2387	2385
	P						10.64	10.57	10.50	10.46	10.46
	A						245.1	274.1	304.3	336.2	369.7
	M						6.35	7.19	8.09	9.04	10.02
	E						64.4	67.7	70.7	73.6	75.7
	%						237.9	228.5	220.6	214.0	209.0
	T										
	130 (491)				13445	15255	17145	19169	21336	23678	26168
	C				2147	2133	2120	2109	2096	2080	2064
P				9.40	9.32	9.27	9.23	9.17	9.10	9.04	
A				201.9	227.6	254.2	282.4	312.3	344.5	378.4	
M				6.26	7.15	8.09	9.09	10.18	11.38	12.68	
E				62.3	66.0	69.1	71.9	74.5	77.0	79.4	
%				235.7	224.2	215.3	207.9	201.4	195.7	191.1	
T											
120 (432)		11493	13102	14839	16740	18732	20862	23167	25641	28260	
C		1901	1892	1882	1871	1859	1847	1830	1811	1799	
P		8.30	8.27	8.22	8.18	8.13	8.07	8.00	7.90	7.85	
A		164.3	186.0	209.1	234.5	260.7	288.6	318.6	350.5	384.1	
M		6.05	6.93	7.89	8.95	10.07	11.30	12.66	14.16	15.71	
E		60.4	63.5	66.6	69.7	72.3	74.6	77.0	79.1	81.0	
%		234.6	222.8	212.6	203.5	196.2	189.9	184.2	179.4	175.7	
T											
110 (380)		11083	12669	14371	16196	18176	20265	22529	24952	27562	30375
C		1677	1672	1662	1654	1643	1630	1614	1596	1574	1560
P		7.33	7.31	7.26	7.21	7.18	7.12	7.05	6.98	6.87	6.82
A		150.4	170.6	192.4	215.4	240.2	266.3	294.2	323.9	356.0	390.3
M		6.61	7.58	8.65	9.79	11.06	12.43	13.96	15.63	17.51	19.47
E		61.1	63.8	66.6	69.5	72.0	74.1	76.1	77.9	79.6	81.3
%		222.6	211.4	201.4	192.6	185.1	178.9	173.4	168.5	164.0	160.6
T											
100 (332)		12140	13791	15565	17477	19525	21715	24081	26621	29398	32411
C		1478	1473	1464	1454	1442	1426	1410	1390	1372	1357
P		6.46	6.42	6.40	6.35	6.30	6.23	6.15	6.07	5.99	5.93
A		155.8	176.0	197.4	220.2	244.5	270.6	298.3	328.1	360.5	395.4
M		8.22	9.37	10.63	12.02	13.54	15.23	17.08	19.16	21.42	23.88
E		63.7	66.2	68.6	70.9	72.9	74.6	75.9	77.1	77.7	78.4
%		200.7	191.0	182.4	174.9	168.6	162.9	158.1	153.7	149.9	146.7
T											
90 (289)		13104	14833	16678	18659	20811	23085	25579	28261	31176	34402
C		1306	1299	1291	1277	1266	1248	1231	1213	1194	1177
P		5.70	5.67	5.63	5.58	5.52	5.45	5.38	5.29	5.22	5.14
A		160.0	180.0	201.2	223.9	248.2	273.8	301.8	331.8	364.4	400.1
M		10.03	11.42	12.92	14.61	16.44	18.50	20.78	23.30	26.12	29.24
E		65.2	67.2	69.2	70.9	72.1	73.0	73.5	73.4	72.5	72.5
%		181.6	173.0	165.4	158.8	153.2	148.3	144.0	140.1	136.8	133.6
T											
80 (250)		14025	15829	17765	19772	22006	24383	26991	29830	32907	
C		1152	1145	1134	1122	1106	1089	1073	1055	1038	
P		5.04	5.01	4.96	4.90	4.84	4.76	4.69	4.61	4.55	
A		163.6	183.6	204.6	226.5	250.7	276.5	304.4	334.7	367.6	
M		12.17	13.82	15.67	17.63	19.90	22.39	25.15	28.29	31.70	
E		65.3	66.8	68.1	68.9	69.3	68.8	67.8	66.0	64.1	
%		164.0	156.4	149.8	144.2	139.1	134.9	131.1	127.7	124.8	
T											
70 (215)		14904	16700	18669	20824	23130	25647				
C		1016	1009	996	981	965	949				
P		4.44	4.42	4.36	4.29	4.22	4.16				
A		166.4	185.4	206.1	228.6	252.6	278.6				
M		14.68	16.55	18.75	21.24	23.98	27.03				
E		63.8	64.4	64.7	64.4	63.6	61.8				
%		148.0	141.8	135.8	130.7	126.2	122.5				
T											

C: Capacity (Btu/hr), P: Power (Watts), A: Current (Amps) at 230V, M: Mass Flow (lbs/hr), E: EER (Btu/Watt-hr)
 %: Isentropic Efficiency (%), T: Discharge Temperature (°F)

Table A2: R-410A at 40°F Superheat, 15°F Subcooling

		Suction Dew Point Temp, °F (Suction Pressure, psia)									
		10 (76)	15 (84)	20 (93)	25 (102)	30 (111)	35 (122)	40 (133)	45 (144)	50 (157)	55 (170)
Discharge Dew Point Temp, °F (Discharge Pressure, psia)	140 (556)						15766	17739	19791	21956	24280
	C						2432	2418	2404	2392	2380
	P						10.65	10.60	10.53	10.47	10.41
	A						232.7	259.8	287.7	316.9	348.1
	M						6.48	7.34	8.23	9.18	10.20
	E						67.7	71.1	74.2	76.8	79.2
	%						256.2	246.7	239.0	232.6	227.0
	T				13724	15537	17471	19483	21670	23961	26417
	130 (491)				2147	2134	2122	2112	2099	2088	2077
	C				9.38	9.33	9.28	9.24	9.18	9.13	9.08
P				192.5	216.3	241.5	267.4	295.3	324.5	355.2	
A				6.39	7.28	8.23	9.23	10.32	11.48	12.72	
M				66.0	69.5	72.8	75.8	78.4	80.7	82.4	
E				253.2	242.5	233.5	226.0	219.6	214.4	210.1	
%											
T											
120 (432)		11717	13354	15147	17006	19002	21150	23417	25857	28466	
C		1898	1888	1876	1868	1859	1847	1832	1816	1804	
P		8.29	8.25	8.20	8.16	8.12	8.07	8.01	7.94	7.87	
A		157.1	177.7	200.1	223.2	247.6	273.6	301.0	330.4	361.3	
M		6.17	7.07	8.07	9.11	10.22	11.45	12.78	14.24	15.78	
E		64.2	67.3	70.8	73.9	76.6	79.2	81.4	82.9	84.5	
%		251.6	240.2	229.7	221.1	214.0	207.7	202.4	197.8	194.2	
T											
110 (380)		11288	12891	14636	16441	18410	20484	22726	25103	27640	30419
C		1672	1664	1656	1647	1638	1626	1612	1597	1578	1565
P		7.30	7.27	7.23	7.20	7.15	7.11	7.05	6.98	6.89	6.84
A		144.3	163.7	184.3	205.7	228.7	252.8	278.7	306.0	335.1	366.4
M		6.75	7.75	8.84	9.98	11.24	12.59	14.09	15.72	17.52	19.44
E		64.8	68.3	71.4	74.2	76.7	79.0	81.0	82.4	83.6	84.6
%		239.7	227.4	217.9	209.5	202.4	196.3	191.0	186.6	182.6	179.6
T											
100 (332)		12346	13995	15751	17671	19701	21892	24192	26692	29417	32287
C		1469	1462	1456	1446	1435	1421	1408	1391	1375	1361
P		6.41	6.39	6.37	6.31	6.27	6.21	6.15	6.08	6.00	5.95
A		150.0	168.9	188.8	210.3	233.0	257.2	282.5	309.9	339.2	370.5
M		8.40	9.57	10.82	12.22	13.73	15.40	17.18	19.19	21.39	23.73
E		68.5	71.0	73.7	76.1	78.2	80.0	80.9	81.6	81.9	81.6
%		216.4	207.2	198.9	191.6	185.6	180.5	176.0	172.1	168.8	166.2
T											
90 (289)		13319	15023	16849	18877	20948	23186	25610	28236	31039	34110
C		1297	1288	1280	1270	1259	1244	1228	1211	1193	1175
P		5.67	5.63	5.59	5.54	5.50	5.43	5.36	5.28	5.21	5.13
A		154.1	172.7	192.5	214.3	236.2	260.0	285.7	313.0	342.4	374.0
M		10.27	11.66	13.17	14.87	16.63	18.64	20.85	23.33	26.02	29.02
E		70.1	72.5	74.5	76.3	77.7	77.5	77.8	77.3	76.0	74.3
%		197.4	189.1	181.9	175.6	170.7	166.6	162.6	159.2	156.2	153.7
T											
80 (250)		14239	16018	17877	19909	22106	24461	27010	29794		
C		1144	1136	1124	1113	1099	1085	1069	1054		
P		5.00	4.96	4.91	4.86	4.80	4.74	4.67	4.61		
A		157.7	176.3	195.5	216.5	238.8	262.9	288.5	316.6		
M		12.45	14.10	15.91	17.89	20.12	22.55	25.27	28.26		
E		70.7	72.3	73.9	74.6	75.1	74.8	73.6	71.9		
%		179.7	172.6	166.4	161.1	156.5	152.4	149.1	146.3		
T											
70 (215)		15068	16873	18814	20933	23236					
C		1007	999	986	972	959					
P		4.40	4.36	4.31	4.25	4.19					
A		160.2	178.3	197.6	218.5	241.0					
M		14.96	16.89	19.08	21.54	24.24					
E		69.7	70.4	70.9	70.9	70.2					
%		163.8	157.8	152.2	147.4	143.4					
T											

C: Capacity (Btu/hr), P: Power (Watts), A: Current (Amps) at 230V, M: Mass Flow (lbs/hr), E: EER (Btu/Watt-hr)
 %: Isentropic Efficiency (%), T: Discharge Temperature (°F)

Table A3: R-410A at Suction Temperature 65°F, 15°F Subcooling

		Suction Dew Point Temp, °F (Suction Pressure, psia)									
		10 (76)	15 (84)	20 (93)	25 (102)	30 (111)	35 (122)	40 (133)	45 (144)	50 (157)	55 (170)
Discharge Dew Point Temp, °F (Discharge Pressure, psia)	140 (556)						15645	17500	19402	21536	23761
	C						2428	2411	2399	2376	2360
	P						10.64	10.57	10.50	10.40	10.35
	A						239.4	270.9	304.3	342.6	384.7
	M						6.44	7.26	8.09	9.07	10.07
	E						66.3	68.9	70.7	73.5	75.3
	%						246.8	232.7	220.6	208.3	198.0
	T										
	130 (491)				13724	15528	17374	19347	21336	23654	26020
	C				2147	2130	2116	2100	2096	2071	2056
	P				9.38	9.32	9.26	9.19	9.17	9.06	9.00
A				192.5	219.9	248.4	279.6	312.3	350.7	391.7	
M				6.39	7.29	8.21	9.21	10.18	11.42	12.65	
E				66.0	69.2	71.8	73.8	74.5	76.9	78.0	
%				253.2	237.2	223.7	211.5	201.4	190.5	181.7	
T											
120 (432)		11804	13536	15147	17025	18961	21020	23167	25663	28282	
C		1896	1883	1876	1865	1854	1838	1830	1802	1781	
P		8.28	8.24	8.20	8.15	8.10	8.03	8.00	7.87	7.78	
A		153.7	177.4	200.1	226.7	254.9	285.7	318.6	357.3	399.5	
M		6.22	7.19	8.07	9.13	10.23	11.44	12.66	14.24	15.88	
E		65.8	69.5	70.8	73.5	75.1	76.7	77.0	79.1	80.3	
%		260.2	242.1	229.7	216.0	204.5	193.6	184.2	174.1	165.2	
T											
110 (380)		11496	13067	14761	16441	18409	20445	22642	24952	27605	30453
C		1667	1660	1653	1647	1635	1624	1607	1596	1567	1545
P		7.28	7.25	7.22	7.20	7.15	7.09	7.01	6.98	6.85	6.75
A		141.2	161.3	183.3	205.7	232.0	260.1	290.7	323.9	362.8	405.7
M		6.90	7.87	8.93	9.98	11.26	12.59	14.09	15.63	17.62	19.71
E		69.1	71.0	73.3	74.2	76.3	77.4	78.3	77.9	79.7	80.1
%		249.2	234.7	220.9	209.5	197.6	187.1	177.1	168.5	158.8	150.2
T											
100 (332)		12499	14137	15874	17671	19714	21862	24176	26621	29470	32521
C		1471	1465	1454	1446	1434	1420	1403	1390	1367	1345
P		6.43	6.40	6.35	6.31	6.27	6.20	6.13	6.07	5.97	5.88
A		146.0	166.0	187.5	210.3	236.1	264.1	294.7	328.1	367.4	410.6
M		8.50	9.65	10.92	12.22	13.74	15.40	17.23	19.16	21.56	24.18
E		72.2	73.9	75.9	76.1	77.5	77.9	78.0	77.1	77.4	76.7
%		227.9	214.7	202.1	191.6	181.0	171.3	162.1	153.7	144.8	136.6
T											
90 (289)		13464	15145	16936	18877	20959	23186	25618	28261	31224	34520
C		1296	1289	1278	1270	1258	1242	1225	1213	1190	1167
P		5.66	5.63	5.58	5.54	5.49	5.42	5.35	5.29	5.20	5.10
A		150.1	169.9	191.1	214.3	239.5	267.1	297.7	331.8	370.6	414.7
M		10.39	11.75	13.25	14.87	16.66	18.67	20.91	23.30	26.25	29.59
E		74.6	75.6	77.0	76.3	76.9	76.4	75.6	73.4	71.9	69.6
%		208.3	196.5	185.0	175.6	165.9	156.9	148.1	140.1	132.0	123.9
T											
80 (250)		14333	16078	17951	19909	22119	24456	27057	29830	32995	
C		1140	1132	1121	1113	1099	1085	1067	1055	1030	
P		4.98	4.95	4.90	4.86	4.80	4.74	4.67	4.61	4.51	
A		153.2	172.6	193.9	216.5	242.0	269.6	300.7	334.7	374.2	
M		12.58	14.21	16.01	17.89	20.13	22.54	25.35	28.29	32.02	
E		75.8	76.0	76.3	74.6	74.3	72.6	70.0	66.0	62.7	
%		190.6	180.0	169.6	161.1	151.8	143.3	135.2	127.7	119.8	
T											
70 (215)		15161	16952	18869	20933	23233	25691				
C		1001	997	983	972	957	945				
P		4.38	4.36	4.30	4.25	4.19	4.14				
A		155.8	174.9	195.8	218.5	244.1	271.8				
M		15.14	17.01	19.20	21.54	24.29	27.18				
E		75.1	74.1	73.5	70.9	68.9	65.1				
%		174.7	165.3	155.4	147.4	138.7	131.2				
T											

C: Capacity (Btu/hr), P: Power (Watts), A: Current (Amps) at 230V, M: Mass Flow (lbs/hr), E: EER (Btu/Watt-hr)
 %: Isentropic Efficiency (%), T: Discharge Temperature (°F)

Table A4: R-32/134a at 20°F Superheat, 15°F Subcooling

		Suction Dew Point Temp, °F (Suction Pressure, psia)										
		10 (74)	15 (81)	20 (90)	25 (98.)	30 (108)	35 (118)	40 (129)	45 (141)	50 (153)	55 (166)	
Discharge Dew Point Temp, °F (Discharge Pressure, psia)	140 (552)									19335	21604	23960
	C									2452	2438	2427
	P									10.75	10.68	10.64
	A									198.8	221.4	244.8
	M									7.89	8.86	9.87
	E									68.7	71.1	73.4
	%									264.3	253.3	243.8
	T											
	130 (487)						16916	18983	21173	23546	26020	
	C						2147	2139	2127	2114	2108	
P						9.39	9.35	9.30	9.24	9.21		
A						166.2	185.9	206.8	229.4	252.7		
M						7.88	8.88	9.96	11.14	12.35		
E						68.3	70.8	73.1	75.0	76.4		
%						260.5	248.8	238.4	229.3	222.0		
T												
120 (428)				14439	16408	18429	20565	22888	25344	27994		
C				1893	1887	1876	1866	1854	1842	1830		
P				8.27	8.25	8.21	8.15	8.09	8.05	8.00		
A				136.4	154.3	172.7	192.1	213.2	235.4	259.5		
M				7.63	8.70	9.82	11.02	12.34	13.76	15.30		
E				66.6	69.4	71.8	73.9	75.7	76.9	78.1		
%				260.3	246.4	234.8	225.0	216.1	208.4	201.7		
T												
110 (375)		12214	13979	15836	17840	19919	22138	24513	27075	29781		
C		1670	1665	1658	1651	1643	1634	1620	1606	1593		
P		7.29	7.27	7.24	7.20	7.17	7.12	7.06	7.01	6.96		
A		111.1	126.7	143.1	160.5	178.6	198.0	218.5	240.9	264.2		
M		7.31	8.40	9.55	10.81	12.12	13.55	15.13	16.86	18.69		
E		64.9	67.4	70.4	72.5	74.2	75.4	76.5	77.0	77.3		
%		261.4	246.6	232.7	221.5	211.9	203.7	196.1	189.3	183.7		
T												
100 (327)		11570	13257	15058	16991	18987	21169	23439	25900	28579	31411	
C		1469	1466	1461	1453	1446	1437	1425	1410	1395	1381	
P		6.41	6.39	6.38	6.34	6.31	6.27	6.22	6.16	6.08	6.03	
A		101.4	115.7	131.1	147.2	164.0	182.2	201.3	221.8	244.0	267.5	
M		7.88	9.04	10.30	11.69	13.13	14.73	16.45	18.36	20.49	22.74	
E		65.2	67.6	70.0	71.9	73.4	74.4	74.8	75.0	74.7	74.2	
%		248.7	234.2	221.0	209.8	200.3	192.0	184.7	178.0	172.1	166.8	
T												
90 (284)		12456	14210	16088	18022	20103	22305	24690	27241	30017	33041	
C		1295	1290	1284	1276	1270	1257	1241	1224	1209	1192	
P		5.65	5.64	5.60	5.57	5.54	5.49	5.41	5.34	5.27	5.20	
A		105.0	119.4	134.5	150.3	167.1	185.0	204.1	224.6	246.8	271.0	
M		9.62	11.01	12.53	14.12	15.83	17.75	19.89	22.25	24.84	27.72	
E		66.9	68.7	70.4	71.7	72.2	72.3	72.0	71.3	69.8	68.1	
%		223.2	210.6	199.2	189.5	181.4	173.9	167.3	161.2	155.9	150.7	
T												
80 (246)		13380	15136	16993	18979	21126	23453	25898	28588	31491		
C		1139	1134	1128	1121	1108	1093	1077	1060	1044		
P		4.98	4.95	4.93	4.89	4.84	4.77	4.71	4.63	4.56		
A		108.7	122.6	137.0	152.6	169.4	187.5	206.5	227.3	249.8		
M		11.74	13.35	15.06	16.92	19.07	21.46	24.05	26.98	30.16		
E		67.2	68.2	69.0	69.3	69.2	68.4	67.0	64.4	61.3		
%		200.5	189.7	180.0	171.5	163.8	156.8	150.9	145.5	140.8		
T												
70 (211)		14175	15916	17823	19831	22090	24505					
C		1002	1000	989	977	964	948					
P		4.38	4.37	4.33	4.28	4.21	4.15					
A		111.2	124.6	139.0	154.2	171.1	189.2					
M		14.14	15.91	18.01	20.30	22.92	25.85					
E		65.7	65.8	65.7	65.2	63.8	61.5					
%		180.2	170.6	162.1	154.2	147.2	141.2					
T												

C: Capacity (Btu/hr), P: Power (Watts), A: Current (Amps) at 230V, M: Mass Flow (lbs/hr), E: EER (Btu/Watt-hr)
 %: Isentropic Efficiency (%), T: Discharge Temperature (°F)

Table A5: R-32/134a at 40°F Superheat, 15°F Subcooling

		Suction Dew Point Temp, °F (Suction Pressure, psia)										
		10 (74)	15 (81)	20 (90)	25 (98.)	30 (108)	35 (118)	40 (129)	45 (141)	50 (153)	55 (166)	
Discharge Dew Point Temp, °F (Discharge Pressure, psia)	140 (552)									21608	23932	
	C									2439	2434	
	P									10.68	10.67	
	A									209.7	231.4	
	M									8.86	9.83	
	E									74.8	76.5	
	%									272.6	264.0	
	T											
	130 (487)								19113	21301	23636	26083
	C								2142	2130	2121	2117
P								9.37	9.33	9.27	9.27	
A								178.0	197.7	218.6	240.3	
M								8.92	10.00	11.15	12.32	
E								75.1	77.4	79.2	80.4	
%								266.9	256.7	248.1	241.1	
T												
120 (428)						16611	18613	20714	22946	25357	27909	
C						1878	1868	1858	1849	1838	1829	
P						8.20	8.17	8.11	8.08	8.03	7.99	
A						149.1	166.4	184.5	203.7	224.2	245.9	
M						8.85	9.96	11.15	12.41	13.80	15.26	
E						74.2	76.8	79.0	80.7	81.9	82.9	
%						263.3	251.8	242.2	233.9	226.7	220.5	
T												
110 (375)				14104	15980	17941	19994	22173	24484	26926	29606	
C				1665	1653	1644	1635	1625	1611	1598	1585	
P				7.27	7.22	7.18	7.14	7.10	7.03	6.98	6.92	
A				122.4	138.1	154.3	171.5	189.4	208.3	228.4	250.2	
M				8.47	9.67	10.91	12.23	13.64	15.20	16.85	18.67	
E				72.1	75.0	77.4	79.2	80.8	81.7	82.4	82.6	
%				262.8	249.8	238.8	229.4	221.3	214.2	207.7	202.3	
T												
100 (327)		11736	13405	15191	17093	19064	21207	23395	25816	28394	31197	
C		1473	1467	1464	1454	1444	1430	1417	1403	1387	1373	
P		6.44	6.41	6.39	6.34	6.31	6.24	6.18	6.13	6.06	6.00	
A		98.8	112.3	126.7	141.9	157.8	174.8	192.1	211.3	231.7	253.7	
M		7.96	9.14	10.38	11.75	13.20	14.83	16.51	18.41	20.48	22.72	
E		69.3	72.1	74.4	76.7	78.4	79.7	80.6	80.7	80.4	79.7	
%		265.1	250.8	238.4	227.1	217.8	209.5	202.3	196.0	190.4	185.5	
T												
90 (284)		12641	14333	16120	18065	20126	22265	24598	27098	29783	32731	
C		1296	1291	1283	1273	1268	1249	1233	1217	1201	1187	
P		5.66	5.64	5.60	5.56	5.53	5.45	5.39	5.32	5.24	5.19	
A		102.5	115.7	129.6	144.7	160.5	177.0	194.9	213.9	234.3	256.8	
M		9.76	11.11	12.57	14.19	15.88	17.82	19.95	22.26	24.80	27.58	
E		71.8	73.7	75.5	77.0	77.4	78.2	78.1	77.3	75.4	73.1	
%		238.8	226.8	216.2	206.6	198.9	191.4	184.9	179.3	174.4	170.0	
T												
80 (246)		13473	15141	16992	18928	21079	23319	25742	28379			
C		1141	1134	1127	1118	1102	1085	1070	1055			
P		4.99	4.95	4.93	4.88	4.82	4.74	4.68	4.61			
A		105.4	118.0	131.9	146.3	162.4	179.1	196.9	216.4			
M		11.81	13.35	15.07	16.93	19.12	21.49	24.05	26.89			
E		72.4	73.9	74.6	75.0	74.9	74.5	72.8	70.6			
%		216.1	205.6	196.7	188.6	181.1	174.4	168.9	163.7			
T												
70 (211)		14204	15946	17801	19808	22031						
C		1003	997	986	972	958						
P		4.39	4.36	4.32	4.26	4.19						
A		107.6	120.1	133.8	148.2	164.1						
M		14.16	16.00	18.05	20.38	22.99						
E		71.7	71.7	71.5	71.0	69.7						
%		195.3	186.6	178.5	171.2	164.7						
T												

C: Capacity (Btu/hr), P: Power (Watts), A: Current (Amps) at 230V, M: Mass Flow (lbs/hr), E: EER (Btu/Watt-hr)
 %: Isentropic Efficiency (%), T: Discharge Temperature (°F)

Table A6: R-32/134a at Suction Temperature 65°F, 15°F Subcooling

		Suction Dew Point Temp, °F (Suction Pressure, psia)									
		10 (74)	15 (81)	20 (90)	25 (98.)	30 (108)	35 (118)	40 (129)	45 (141)	50 (153)	55 (166)
Discharge Dew Point Temp, °F (Discharge Pressure, psia)	140 (552)								19335	21611	24005
	C								2452	2421	2404
	P								10.75	10.61	10.53
	A								198.8	224.8	252.9
	M								7.89	8.93	9.98
	E								68.7	71.1	72.4
	%								264.3	247.0	232.5
	T										
	130 (487)						16986	19045	21173	23587	26155
	C						2144	2130	2127	2104	2090
P						9.38	9.31	9.30	9.21	9.13	
A						162.8	184.2	206.8	232.9	261.6	
M						7.92	8.94	9.96	11.21	12.51	
E						70.3	72.3	73.1	74.8	75.2	
%						269.8	252.6	238.4	223.5	210.6	
T											
120 (428)						16406	18416	20570	22888	25379	28037
C						1886	1868	1856	1854	1832	1816
P						8.25	8.17	8.11	8.09	8.01	7.95
A						148.9	168.5	189.8	213.2	238.9	267.0
M						8.70	9.86	11.08	12.34	13.86	15.44
E						72.3	74.2	75.4	75.7	76.5	76.5
%						260.5	243.7	229.0	216.1	202.9	191.2
T											
110 (375)			13969	15980	17779	19900	22117	24513	27095	29920	
C			1670	1653	1655	1642	1622	1620	1596	1579	
P			7.29	7.22	7.22	7.17	7.08	7.06	6.97	6.90	
A			120.0	138.1	154.7	174.4	195.3	218.5	244.1	272.7	
M			8.37	9.67	10.74	12.12	13.64	15.13	16.97	18.95	
E			72.2	75.0	75.7	76.6	77.2	76.5	76.6	75.4	
%			268.7	249.8	235.4	221.1	207.6	196.1	183.9	173.1	
T											
100 (327)			13274	15025	17093	18969	21097	23411	25900	28655	31570
C			1471	1464	1454	1447	1439	1417	1410	1387	1373
P			6.42	6.40	6.34	6.32	6.28	6.19	6.16	6.06	6.00
A			109.0	124.1	141.9	158.5	177.6	198.7	221.8	247.7	275.8
M			9.03	10.26	11.75	13.11	14.67	16.52	18.36	20.65	23.00
E			73.6	75.0	76.7	76.9	76.6	76.5	75.0	74.0	71.8
%			259.9	243.4	227.1	213.9	201.6	188.9	178.0	166.7	156.7
T											
90 (284)		12517	14173	15987	18065	20039	22272	24648	27241	30126	33249
C		1296	1291	1285	1273	1268	1250	1235	1224	1203	1186
P		5.66	5.64	5.61	5.56	5.54	5.46	5.39	5.34	5.26	5.19
A		98.7	112.3	127.2	144.7	161.5	180.6	201.5	224.6	250.7	279.6
M		9.66	10.98	12.44	14.19	15.80	17.82	19.95	22.25	25.04	28.03
E		75.1	75.9	76.4	77.0	76.2	75.4	74.0	71.3	69.0	65.4
%		235.3	220.9	206.6	194.6	182.7	171.4	161.2	150.4	140.8	
T											
80 (246)		13343	15044	16972	18928	21049	23375	25873	28588	31569	
C		1137	1133	1128	1118	1106	1088	1073	1060	1041	
P		4.97	4.95	4.92	4.88	4.84	4.75	4.69	4.63	4.55	
A		101.6	115.1	130.4	146.3	163.7	183.0	204.1	227.3	253.2	
M		11.74	13.28	15.05	16.93	19.03	21.49	24.12	26.98	30.33	
E		76.5	76.4	76.5	75.0	73.3	71.5	68.8	64.4	60.1	
%		227.4	213.8	199.8	188.6	177.1	165.6	155.0	145.5	135.9	
T											
70 (211)		14149	15858	17763	19808	22019	24412				
C		999	995	986	972	959	943				
P		4.37	4.35	4.31	4.26	4.20	4.13				
A		104.2	117.6	132.1	148.2	165.7	184.8				
M		14.17	15.93	18.01	20.38	22.96	25.88				
E		76.5	75.1	73.7	71.0	68.2	64.5				
%		205.9	193.9	181.8	171.2	160.2	150.0				
T											

C: Capacity (Btu/hr), P: Power (Watts), A: Current (Amps) at 230V, M: Mass Flow (lbs/hr), E: EER (Btu/Watt-hr)
 %: Isentropic Efficiency (%), T: Discharge Temperature (°F)

Appendix B

Performance Maps

- Capacity, Input Power, and EER

Figure B1 to B8 present measured capacity, input power, EER, and isentropic efficiency as a function of suction dew point temperature for given discharge dew point temperature at 20°F superheat and 15°F subcooling for baseline and the alternative refrigerant tested.

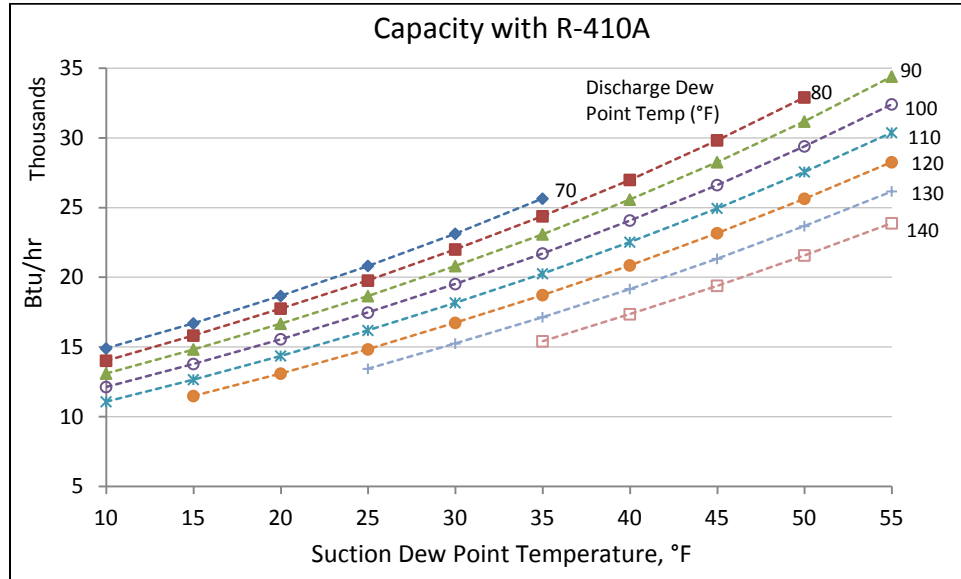

Figure B1 Capacity with R-410A.

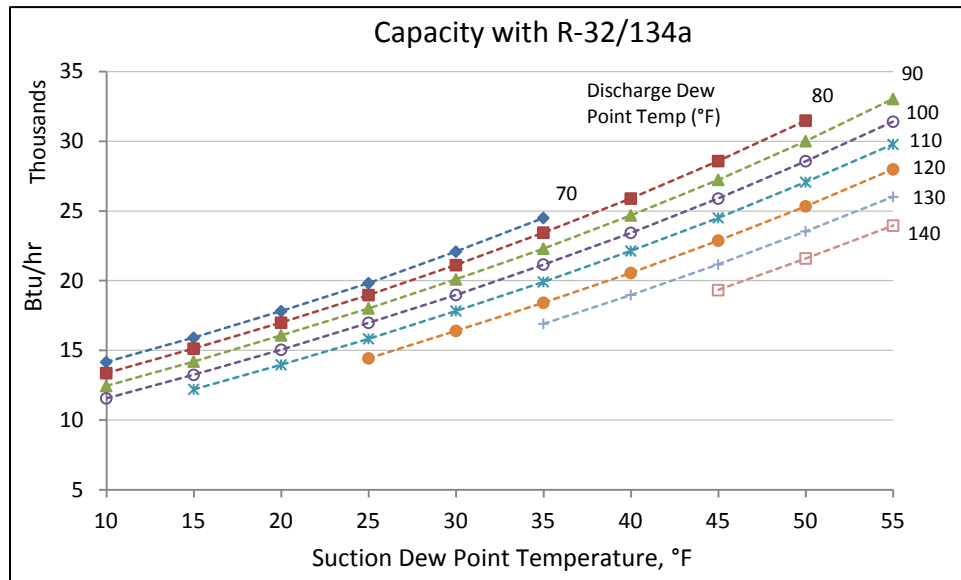

Figure B2 Capacity with R-32/134a.

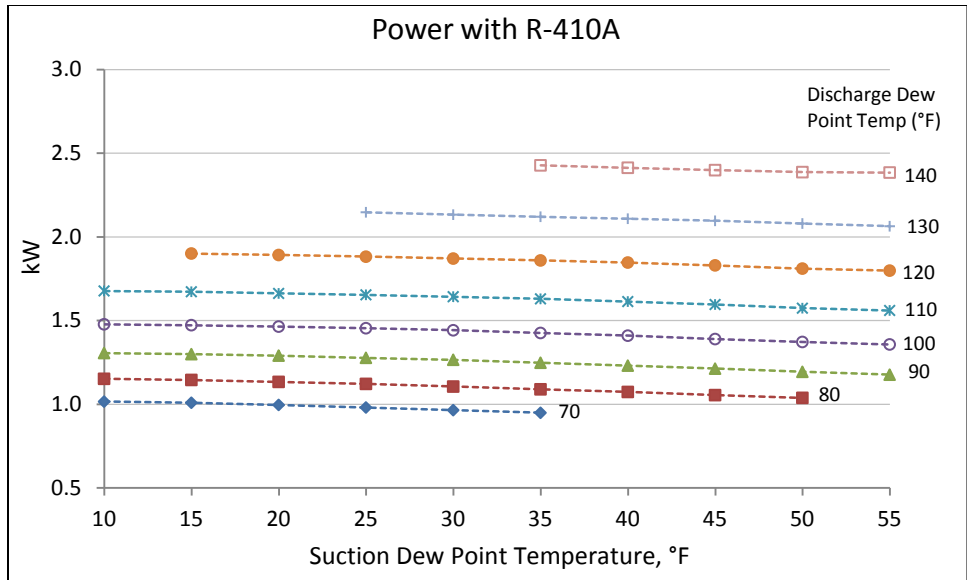

Figure B3 Power with R-410A.

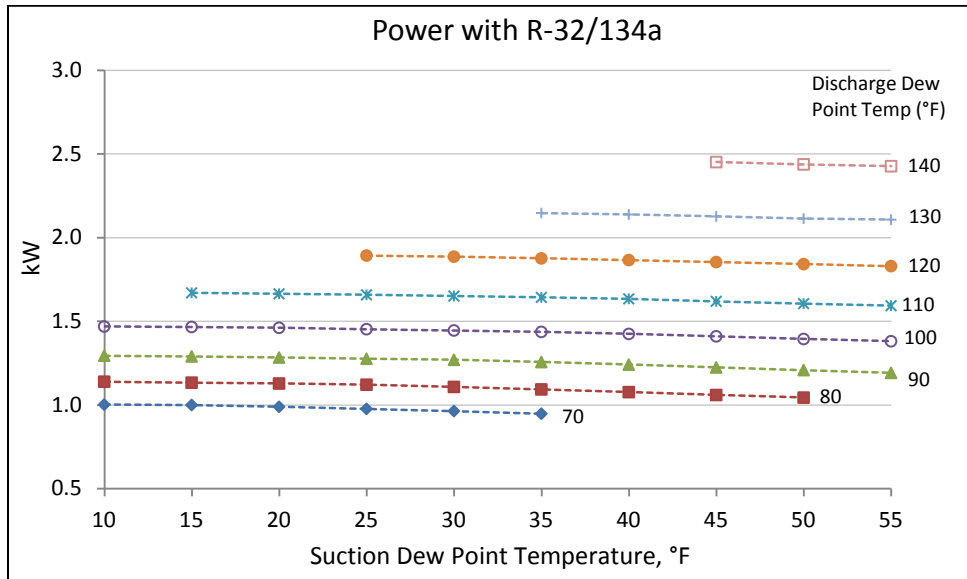

Figure B4 Power with R-32/134a.

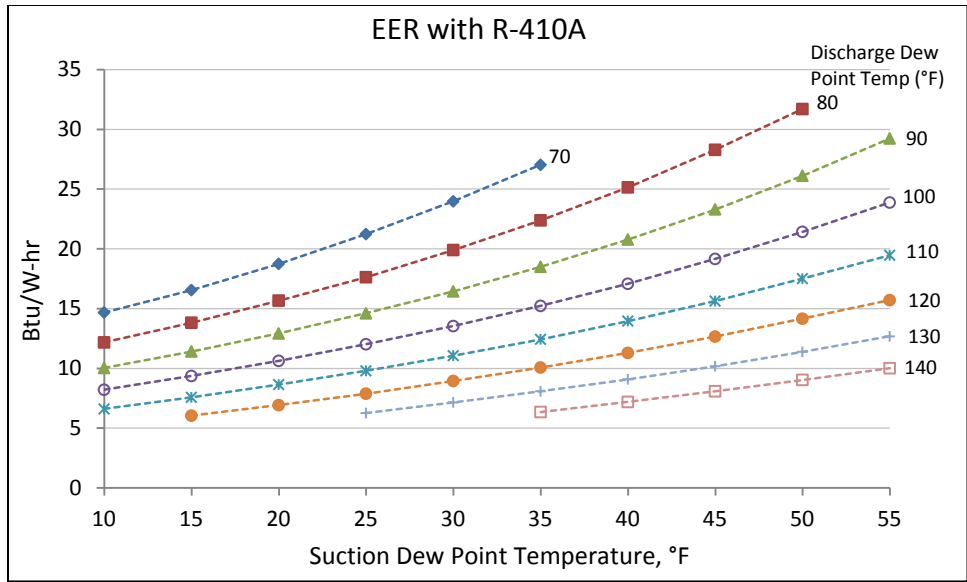

Figure B5 EER with R-410A.

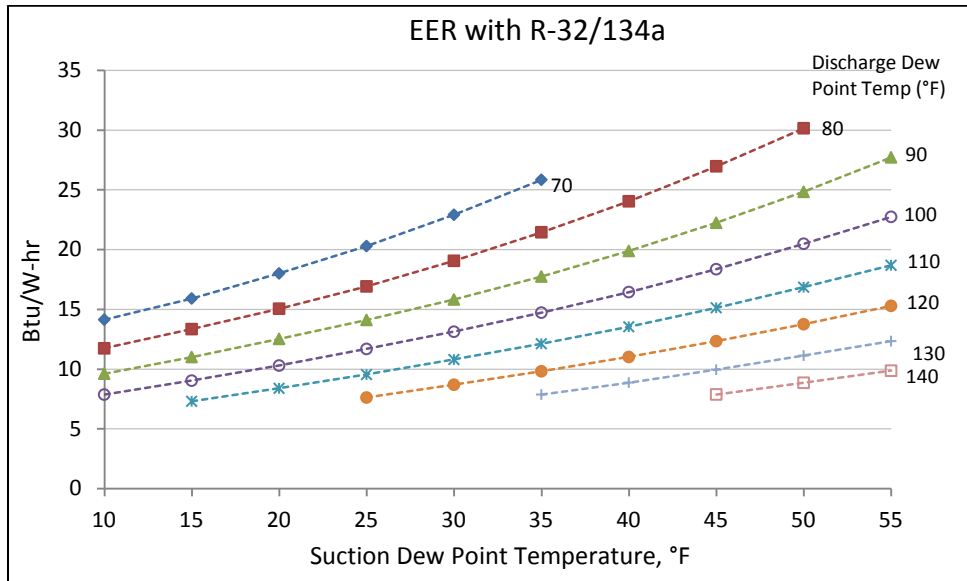

Figure B6 EER with R-32/134a.

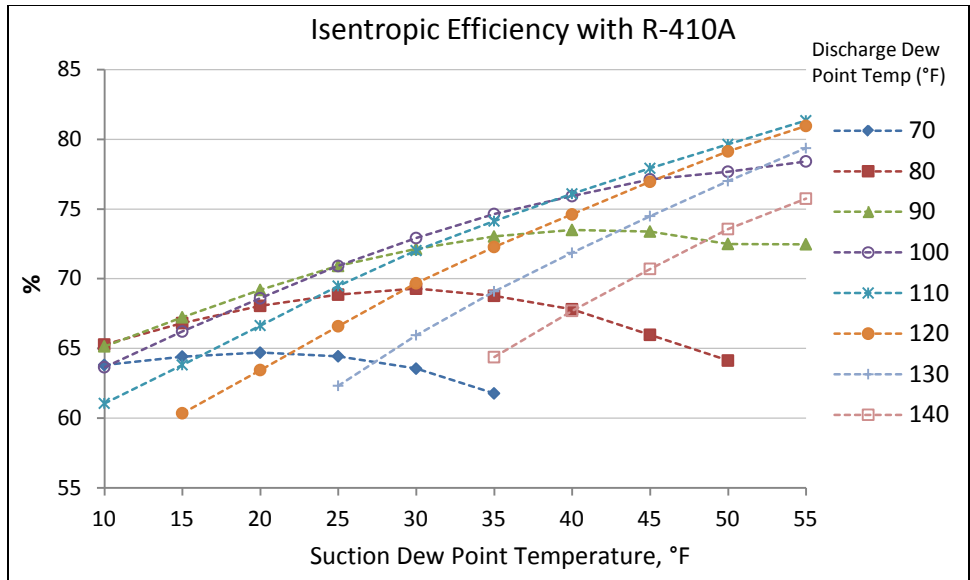

Figure B7 Isentropic efficiency with R-410A.

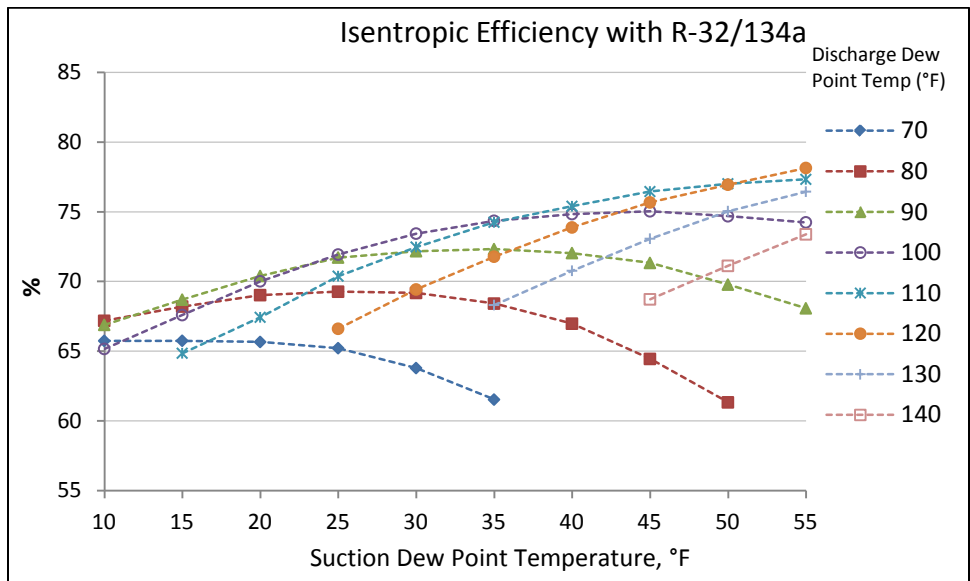

Figure B8 Isentropic efficiency with R-32/134a.

- 10-Coefficient polynomial equation for each test refrigerant

Table B1 provide the 10 coefficients for mass flow rate, capacity, power, EER, and discharge temperature polynomials for R-410A and R-32/134a, respectively, as a function of suction dew point temperature and discharge dew point temperature. These coefficients are derived from the test data at 20°F superheat and 15°F subcooling. The standard form of the 10-coefficient polynomial is given as follows:

$$X = C_1 + C_2*S + C_3*D + C_4*S^2 + C_5*S*D + C_6*D^2 + C_7*S^3 + C_8*D*S^2 + C_9*S*D^2 + C_{10}*D^3$$

Where:

C = Equation coefficient, represents compressor performance

S = Suction dew point temperature. °F

D = Discharge dew point temperature. °F

X = Compressor performance (mass flow rate, capacity, power, EER, discharge temperature)

Table B1: 10 Coefficients for R-410A

Coefficient	Mass Flow, lbs/hr	Capacity, Btu/hr	Power, W	EER, Btu/W-hr	Discharge Temperature, °F
C ₁	1.416E+02	1.511E+04	1.157E+02	3.830E+01	7.277E+01
C ₂	3.038E+00	3.384E+02	-4.824E-01	1.019E+00	-1.101E+00
C ₃	-1.754E-01	-2.733E+01	1.637E+01	-6.426E-01	1.145E+00
C ₄	2.988E-02	3.785E+00	-5.290E-02	9.293E-03	3.854E-03
C ₅	-1.455E-03	-5.440E-01	-1.026E-02	-1.511E-02	2.937E-03
C ₆	2.760E-03	-2.982E-01	-9.892E-02	4.716E-03	-1.165E-03
C ₇	2.564E-04	2.527E-02	2.760E-04	3.202E-05	-1.850E-04
C ₈	-1.880E-04	-2.914E-02	-7.877E-05	-8.849E-05	3.060E-04
C ₉	7.668E-05	1.752E-03	1.641E-04	6.958E-05	-1.958E-04
C ₁₀	-3.381E-05	-4.043E-04	7.214E-04	-1.507E-05	4.977E-05

Table B2: 10 Coefficients for R-32/134a

Coefficient	Mass Flow, lbs/hr	Capacity, Btu/hr	Power, W	EER, Btu/W-hr	Discharge Temperature, °F
C ₁	-4.408E+06	-5.013E+08	2.353E+06	-3.478E+05	2.320E+06
C ₂	1.967E+04	2.245E+06	-1.059E+04	1.571E+03	-1.016E+04
C ₃	-1.261E+04	-1.473E+06	7.246E+03	-1.096E+03	5.498E+03
C ₄	-2.940E+01	-3.367E+03	1.599E+01	-2.383E+00	1.490E+01
C ₅	3.931E+01	4.624E+03	-2.290E+01	3.527E+00	-1.705E+01
C ₆	-1.767E+01	-2.165E+03	1.116E+01	-1.884E+00	7.448E+00
C ₇	1.471E-02	1.691E+00	-8.085E-03	1.213E-03	-7.326E-03
C ₈	-3.064E-02	-3.628E+00	1.811E-02	-2.831E-03	1.325E-02
C ₉	2.772E-02	3.410E+00	-1.782E-02	3.006E-03	-1.176E-02
C ₁₀	-8.778E-03	-1.109E+00	6.741E-03	-1.051E-03	3.869E-03