

AHRI Standard 1410-2017 (R2024) (I-P)

Performance Rating of Commercial Finned Tube Radiation



2311 Wilson Blvd, Suite 400
Arlington, VA 22201 USA
www.ahrinet.org
Phone: (703) 524-8800

we make life better®



©Copyright 2024, by Air-Conditioning, Heating, and Refrigeration Institute
Registered United States Patent and Trademark Office
Printed in USA

**IMPORTANT
SAFETY DISCLAIMER**

AHRI does not set safety standards and does not certify or guarantee the safety of any products, components or systems designed, tested, rated, installed or operated in accordance with this standard/guideline. It is strongly recommended that products be designed, constructed, assembled, installed and operated in accordance with nationally recognized safety standards and code requirements appropriate for products covered by this standard/guideline.

AHRI uses its best efforts to develop standards/guidelines employing state-of-the-art and accepted industry practices. AHRI does not certify or guarantee that any tests conducted under its standards/guidelines will be non-hazardous or free from risk.

Note:

This standard supersedes IBR Testing and Rating Standard for Finned Tube (Commercial) Radiation, Sixth Edition, July 2005

This standard was reaffirmed May 2024.

AHRI CERTIFICATION PROGRAM DISCLAIMER

AHRI standards, guidelines, and appendices are developed independently of AHRI Certification activities and can have scopes that include products that are not part of the AHRI Certification Program. The scope of the applicable AHRI Certification Program can be found on AHRI's website at <http://www.ahrinet.org>.

TABLE OF CONTENTS

SECTION	PAGE
Section 1. Purpose	1
Section 2. Scope	1
Section 3. Definitions	1
Section 4. Test Requirements	3
Section 5. Rating Requirements.....	3
Section 6. Nomenclature.....	4
Section 7. Minimum Data Requirements for Published Ratings	5
Section 8. Marking and Nameplate Data	6
Section 9. Conformance Conditions	6

TABLES

Table 1. Conditions for Standard Rating Tests	3
Table 2. Heating Effect (HE) Calculation Table of Maximum Addition to Capacity Percentages	4
Table 3. Nomenclature.....	5

APPENDICES

Appendix A. References – Normative.....	7
Appendix B. References – Informative.....	7
Appendix C. Method of Testing for Performance Rating of Commercial Finned Tube Radiation – Normative....	8
Appendix D. Sources of Error in Steam Finned Tube Unit Test Procedures – Informative.....	24
Appendix E. Tables for Determining Ratings for Multiple Tier Elements of Various CFTR Product Types – Informative	25
Appendix F. Tables for Determining AHRI Water Ratings at Average Water Temperature Based on the AHRI Steam Rating – Informative.....	40
Appendix G. Tables for Determining Ratings for Flat Top Covers Based on the AHRI Steam Rating – Informative	47
Appendix H. Tables for Determining Ratings for Expanded Metal Covers Based on the AHRI Steam Rating of a Bare Element – Informative	50
Appendix I. Sample Test Reports/Data Sheets – Informative	53

TABLES FOR APPENDICES

Table C1.	Equipment Accuracy Requirements.....	14
Table C2.	Properties of Water	22
Table E1.	Condensation Capacity of 2 in IPS 4-1/4 in Steel Units - Bare (Painted), Two Tiers	26
Table E2.	Condensation Capacity of 2 in IPS 4-1/4 in Steel Units - Bare (Painted), Three Tiers	27
Table E3.	Condensation Capacity of 1-1/4 in IPS 4-1/4 in Steel Units - Bare (Painted), Two Tiers	28
Table E4.	Condensation Capacity of 1-1/4 in IPS 4-1/4 in Steel Units - Bare (Painted), Three Tiers	29
Table E5.	Condensation Capacity of 1-1/4 in IPS 3-1/4 in Steel Units - Bare (Painted), Two Tiers	30
Table E6.	Condensation Capacity of 1-1/4 in IPS 3-1/4 in Steel Units - Bare (Painted), Three Tiers	31
Table E7.	Condensation Capacity of 1-1/4 in Copper 4-1/4 in Aluminum Units – Bare (Unpainted), Two Tiers	32
Table E8.	Condensation Capacity of 1-1/4 in Copper 4-1/4 in Aluminum Units - Bare (Unpainted) , Three Tiers	33
Table E9.	Condensation Capacity of 1-1/4 in Copper 4-1/4 in Aluminum Units – Bare (Painted), Two Tiers.....	34
Table E10.	Condensation Capacity of 1-1/4 in Copper 4-1/4 in Aluminum Units - Bare (Painted), Three Tiers.....	35
Table E11.	Condensation Capacity of 1-1/4 in Copper 3-1/4 in Aluminum Units – Bare (Unpainted), Two Tiers	36
Table E12.	Condensation Capacity of 1-1/4 in Copper 3-1/4 in Aluminum Units – Bare (Unpainted), Three Tiers	37
Table E13.	Condensation Capacity of 1-1/4 in Copper 3-1/4 in Aluminum Units – Bare (Painted), Two Tiers.....	38
Table E14.	Condensation Capacity of 1-1/4 in Copper 3-1/4 in Aluminum Units – Bare (Painted), Three Tiers.....	39
Table F.	AHRI Water Ratings at Average Water Temperature, Btu/h·ft	41
Table G.	Flat Top Cover Steam Ratings, Btu/h·ft	48
Table H.	Expanded Metal Cover Steam Ratings, Btu/h·ft.....	51

FIGURES FOR APPENDICES

Figure C1.	Test Unit Wall Construction	10
Figure C2.	Location of Thermometers/Thermocouples for Measuring Air Temperature.....	12
Figure C3.	Location of Thermometers/Thermocouples in Front of the Test Unit	13

Figure C4.	Suggested Construction of Thermometer/Thermocouple Shield of Bright Metal	13
Figure C5.	Suggested Methods and Equipment for Supplying Steam to the Finned Tube Unit and Measuring the Condensate	16
Figure C6.	Installation Bare Dimensions	17
Figure C7.	Installation in Cover or Enclosure Dimensions	18

PERFORMANCE RATING OF COMMERCIAL FINNED TUBE RADIATION

Section 1. Purpose

1.1 *Purpose.* The purpose of this standard is to establish for commercial finned tube radiation: definitions; test requirements; rating requirements; nomenclature; minimum data requirements for Published Ratings; marking and nameplate data; and conformance conditions.

1.1.1 *Intent.* This standard is intended for the guidance of the industry, including manufacturers, engineers, installers, contractors and users.

1.1.2 *Review and Amendment.* This standard is subject to review and amendment as technology advances.

Section 2. Scope

2.1 *Scope.* This standard applies to steam or water heated room heaters composed of a finned tube element fabricated from metallic tubing with a plurality of metallic fins attached to the tubing by means of a mechanical or other type bond. These heaters are designed for installation bare, or with Open Type Grilles, Covers, or Enclosures having top, front, or inclined outlets.

2.1.1 *Commercial Finned Tube Bare Element.* Commercial finned tube bare elements shall apply to elements fabricated from metallic tubing with a plurality of metallic fins attached to the tubing by means of a mechanical or other type bond.

2.1.2 *Commercial Finned Tube Assembly.* Commercial finned tube assembly shall apply to a steam or water heated commercial finned tube bare element with Open Type Grilles, Covers, or Enclosures having top, front or inclined outlets. These assemblies do not have a back panel that touches the floor.

2.1.3 *Exclusions.* This standard does not apply to the following:

2.1.3.1 Heaters that do not radiate their energy into a single measuring plane;

2.1.3.2 Residential baseboard radiation, covered by the I=B=R Testing and Rating Standard for Baseboard Radiation, and;

2.1.3.3 Convectors, which are designed only for installation in an Enclosure.

Section 3. Definitions

All terms in this document will follow the standard industry definitions in the *ASHRAE Terminology* website (<https://www.ashrae.org/resources--publications/free-resources/ashrae-terminology>) unless otherwise defined in this section.

3.1 *Active Length.* The length of the finned section of the finned tube element. It shall not include any piping or connections beyond the heating element.

3.2 *AHRI Steam Rating.* The Condensation Capacity of the finned tube at AHRI Standard Rating Conditions, plus an added Heating Effect, which is dependent on the installation height and type of installation. AHRI Steam Ratings are expressed in Btu per hour per linear foot of Active Length (Btu/h·ft), and also may be expressed in Square Feet of Steam per Linear Foot of Active Length.

3.3 *Commercial Finned Tube Radiation.* A steam or water heated room heater composed of a finned tube element fabricated from metallic tubing with a plurality of metallic fins attached to the tubing by means of a mechanical or other type of bond. The Commercial Finned Tube is designed for bare installation, or with Open Type Grilles, covers, or enclosures having top, front or inclined outlets. A Commercial Finned Tube does not include room heaters having this type of heating element which are designed with Enclosures to replace baseboards covered by the AHRI Testing and Rating Standard for Baseboard Radiation. A Commercial Finned Tube does not include room heaters, commonly called “convectors”, which are designed exclusively for installation in an Enclosure.

3.4 *Condensation Capacity.* The total heat output of the unit divided by the Active Length of the unit, expressed in Btu/h·ft.

3.5 *Cover.* A shield fabricated with at least a portion of the front skirt composed of non-perforated solid material, mounted on the finned tube element so that there is clearance between the wall and the Cover, and the rear of the finned tube element is not completely enclosed by the Cover. A Cover may have a top, front, or inclined outlet.

3.6 *Convactor.* A heat-distributing unit that operates with gravity circulated air (natural convection). It has a heating element with a large amount of secondary surface and contains two or more tubes (at the same elevation) with headers at both ends. The heating element is surrounded by an Enclosure with an air inlet below and an air outlet above the heating element.

3.7 *Enclosure.* A shield fabricated of solid material installed so that the finned tube element is completely enclosed at both front and rear. An Enclosure may have an integral back and shall not touch the floor, or may be installed tightly against the wall so that the wall itself becomes the back. An Enclosure may have a top, front or inclined outlet.

3.8 *Heating Effect.* Reflects the ability of the unit to direct its heat output to the occupied zone of a room. The application of a Heating Effect factor implies that some units use less steam or hot water than others to produce an equal comfort effect in a room.

3.9 *Installed Height.* The vertical distance of the Commercial Finned Tube (Figure C6, Dimension E), as recommended by the manufacturer, measured at mid-length (at the middle of the Active Length), as defined in Figure C7.

3.10 *Open Type Grille.* The shield fabricated of expanded metal or perforated materials, which covers the top and front of the finned tube element. It does not apply to any Cover or Enclosure which has a solid front panel, or skirt, which provides a stack effect for the air flowing over the element.

3.11 *Output Heating Capacity.* The rate of useful heat output when operating under steady-state conditions.

3.12 *Published Rating.* A statement of the assigned values of those performance characteristics, under stated Rating Conditions, by which a unit may be chosen to fit its application. These values apply to all units of like nominal size and type (identification) produced by the same manufacturer. The term Published Rating includes the rating of all performance characteristics shown on the unit or published in specifications, advertising or other literature controlled by the manufacturer, at stated Rating Conditions.

3.12.1 *Application Rating.* A rating based on tests performed at Application Rating Conditions (other than Standard Rating Conditions).

3.12.2 *Standard Rating.* A rating based on tests performed at Standard Rating Conditions.

3.13 *Rating Conditions.* Any set of operating conditions under which a single level of performance results and which causes only that level of performance to occur.

3.13.1 *Standard Rating Conditions.* Rating Conditions used as the basis of comparison for performance characteristics.

3.14 *Square Feet of Steam per Linear Foot of Active Length.* Is a unit of measurement of power or heat flow rate based on the Active Length of the radiator.

3.15 *"Shall" or "Should".* "Shall" or "should" shall be interpreted as follows:

3.15.1 *Shall.* Where "shall" or "shall not" is used for a provision specified, that provision is mandatory if compliance with the standard is claimed.

3.15.2 *Should.* "Should" is used to indicate provisions which are not mandatory but which are desirable as good practice.

3.16 *Total Length.* Total Length is the overall length of the Commercial Finned Tube or Enclosure, excluding boxes added to the ends of the unit to conceal pipe connections and valves.

Section 4. Test Requirements

4.1 *Test Requirements.* Published Ratings shall be verified by tests conducted in accordance with the test method described in Appendix C and in accordance with the rating requirements of Section 5.

Section 5. Rating Requirements

5.1 *Standard Ratings.* Standard Ratings shall be established at the Standard Rating Conditions specified in Section 5.2.

5.2 *Standard Rating Conditions.* The conditions of test for Standard Ratings shall be established at the Standard Rating Conditions specified in Table 1.

Table 1. Conditions for Standard Rating Tests		
Unit Rating	Air Temperature, °F	Saturated Steam Temperature, °F
Steam Output Heating Capacity, Btu/h·ft	65	215

5.2.1 *Barometric Pressure.* All tested ratings shall be corrected to standard atmospheric pressure of 29.92 in Hg.

5.3 *Rounding Requirements.* The Published Rating shall be rounded to the nearest 10 Btu/h·ft of the Output Heating Capacity calculated in accordance with Appendix C.

5.4 *Heating Effect.* A Heating Effect (HE) shall be added to the steam output heating capacity. The Heating Effect shall be calculated as follows:

5.4.1 *Heating Effect for Installed Height Less than 36 in.* If the Installed Height of a finned tube unit is less than 36 in, the following maximum percentages may be added to the Condensation Capacity For Standard Rating Conditions (H_s).

5.4.1.1 *Bare Elements, Open Type Grille or Cover Heating Effect.* For a finned tube unit installed bare or in an Open Type Grille or a Cover, the maximum percentages which may be added shall be taken from Table 2.

Table 2. Heating Effect (HE) Calculation Table of Maximum Addition to Capacity Percentages	
Installed Height, in	Maximum Addition to Capacity Percentages, %
36 or more	0
34	1
32	2
30	3
29	4
28	5
27	6
26	7
25	8
24	9
23	10
22	11
21	12
20	13
19	14
18 or less	15

5.4.1.2 Front Outlet Enclosure Heating Effect. For a front outlet Enclosure, the maximum percentages which may be added shall be determined per Table 2.

5.4.1.3 Inclined Outlet Enclosure Heating Effect. For an inclined outlet Enclosure, the maximum percentage shall be the percentage shown in Table 2, multiplied by x, where:

$$x = \frac{\text{Angle of outlet to horizontal}}{90} \tag{1}$$

where:

x = Maximum Heating Effect Percentage, %

5.4.1.2 Top Outlet Enclosure Installations. For a top outlet Enclosure, no additions shall be made to the Condensation Capacity.

5.4.2 Heating Effect for Installed Height 36 in or Greater. If the Installed Height of a finned tube unit is 36 in or greater, no addition shall be made to the Condensation Capacity for standard rating conditions (H_s).

5.4.3 Output Heating Capacity. The Output Heating Capacity (H_{out}) is determined by adding the Heating Effect to the Condensation Capacity for standard rating conditions (H_s).

$$H_{out} = H_s (1 + HE) \tag{2}$$

where:

HE = Heating Effect, %
 H_{out} = Output Heating Capacity, Btu/h·ft
 H_s = Condensation capacity for standard rating conditions, Btu/h·ft

Section 6. Nomenclature

6.1 Nomenclature. All symbols and variables used in the standard are defined as shown in Table 3.

Table 3. Nomenclature		
Symbol	Title	Unit
C_b	Correction Factor for Barometric Pressure	-
C_{exp}	Expanded Metal Cover Factor	-
C_s	Correction Factor for Steam and Air Temperature	-
G_{area}	Free area of the grille	in ² /ft
H_c	Condensation Capacity	Btu/h·ft
HE	Heating Effect	%
H_{exp}	Heating Capacity of an Expanded Metal Cover	Btu/h·ft
h_{fg}	Latent Heat of Steam	Btu/lb
H_{out}	Output Heating Capacity	Btu/h·ft
H_s	Condensation Capacity for Standard Rating Conditions	Btu/h·ft
L_a	Active Length of Finned Tube Unit	ft
L_c	Length of Permanent Condensate Piping	in
L_{sp}	Length of Substitute Piping	in
P_b	Barometric pressure	in Hg
P_s	Absolute Steam Pressure	in Hg or psia
R_1	Ratio of free area of the grille to the projected area of the fins	-
R_g	Gross Condensation Rate	lb/h
R_{net}	Net Condensation Rate	lb/h
R_{nl}	Condensation Rate under No-Load Correction	lb/h
t	Duration of Test	h
T_a	Air Temperature	°F
T_{s1}	Saturated Steam Temperature Corresponding to Pressure	°F
T_{s2}	Supply Steam Superheat Temperature	°F
T_{s3}	Steam Supply Temperature	°F
W_c	Total Weight of Condensate During Test	lb

Section 7. Minimum Data Requirements for Published Ratings

7.1 *Minimum Data Requirements for Published Ratings.* As a minimum, Published Ratings shall include all Standard Ratings. All claims to ratings within the scope of this standard shall include the statement “Rated in accordance with AHRI Standard 1410”. All claims to ratings outside the scope of this standard shall include the statement “Outside the scope of AHRI Standard 1410”. Wherever Application Ratings are published or printed, they shall include a statement of the conditions at which the ratings apply.

The following shall be reported for each appropriate model(s):

- 7.1.1** Model number
- 7.1.2** Fin size
- 7.1.3** Fin thickness
- 7.1.4** Fin finish

- 7.1.5 Fin material
- 7.1.6 Fins per foot
- 7.1.7 Nominal tube diameter
- 7.1.8 Tube material
- 7.1.9 Installed height

Section 8. Marking and Nameplate Data

8.1 *Marking and Nameplate Data.* This product does not carry a nameplate.

Section 9. Conformance Conditions

9.1 *Conformance.* While conformance with this standard is voluntary, conformance shall not be claimed or implied for products or equipment within the standard's *Purpose* (Section 1) and *Scope* (Section 2) unless such product claims meet all of the requirements of the standard and all of the testing and rating requirements are measured and reported in complete compliance with the standard. Any product that has not met all the requirements of the standard shall not reference, state, or acknowledge the standard in any written, oral, or electronic communication.

APPENDIX A. REFERENCES – NORMATIVE

A1 Listed here are all standards, handbooks, and other publications essential to the formation and implementation of the standard. All references in this appendix are considered as part of this standard.

A1.1 ASHRAE Terminology, <https://www.ashrae.org/resources--publications/free-resources/ashrae-terminology>, 2017, American Society of Heating, Refrigerating and Air-Conditioning Engineers, Inc., 1791 Tullie Circle, N.E., Atlanta, GA 30329, USA

APPENDIX B. REFERENCES – INFORMATIVE

B1 Listed here are standards, handbooks and other publications which may provide useful information and background but are not considered essential. References in this appendix are not considered part of the standard.

B1.1 *ASHRAE Systems and Equipment Handbook, Chapter 46, Pipes, Tubes and Fittings*, 2016, American Society of Heating, Refrigerating and Air-Conditioning Engineers, Inc., 1791 Tullie Circle, N.E., Atlanta, GA 30329, USA.

B1.2 *ASHRAE Systems and Equipment Handbook, Chapter 36, Hydronic Heat-Distributing Units and Radiators*, 2016, American Society of Heating, Refrigerating and Air-Conditioning Engineers, Inc., 1791 Tullie Circle, N.E., Atlanta, GA 30329, USA.

B1.3 J. H. Keenan, F. G. Keyes, P. G. Hill, and J. G. Moore, *Steam Tables — Thermodynamic Properties of Water Including Vapor, Liquid, and Solid Phases*, Wiley, New York, 1969.

APPENDIX C. METHOD OF TESTING FOR PERFORMANCE RATING OF COMMERCIAL FINNED TUBE RADIATION - NORMATIVE

C1 *Purpose.* The purpose of this appendix is to provide a method of testing for obtaining the steam output heating capacity of a Commercial Finned Tube under Standard Rating Conditions.

C2 *Scope.* Refer to Section 2 of the standard.

C3 *Test Equipment.*

C3.1 *Test Room.* Tests shall be conducted in a warm-wall booth.

C3.1.1 *Test Room Types.* Tests shall be conducted in a warm-wall booth as described below.

C3.1.1.1 *Warm-Wall Booth.* A warm-wall booth shall have one side open and is located in a larger room. The open side of the booth shall have a shield projecting down vertically one foot from the ceiling. The test booth shall be shielded from the radiant effects of any auxiliary heating or cooling equipment. The air in the booth shall be free from draft, except that created by the finned tube unit under test in the course of its normal operation.

Note: The larger room may be provided with a controlled means of maintaining desired temperatures.

C3.1.2 *Test Room Requirements.* The test room shall have the following characteristics.

C3.1.2.1 *Size.* The floor area of the test room or booth shall not be less than 100 ft² and not more than 300 ft². No side wall shall be less than 9 ft long. The ceiling height shall be not less than 8 ft or more than 10 ft.

C3.1.2.2 *Floor.* The floor shall be tight and constructed of commercial wood flooring. The floor of a warm-wall booth shall be at least 1 ft and not more than 4 ft above the floor of the larger room.

C3.1.2.3 *Ceiling.* A non-metallic ceiling shall be used. The inside ceiling shall be painted sheetrock. The ceiling of a warm-wall booth shall be not less than 1 ft from the ceiling of the larger room.

C3.1.2.4 *Walls.* Non-metallic walls shall be used. The inside walls shall be painted sheetrock or plaster. The distance between any wall of a warm-wall booth and the wall of the surrounding room shall be not less than 2 ft.

C3.1.2.5 *Wall Against Which Test Unit Is Placed.* The wall against which the finned tube unit is placed for test shall be the wall opposite the open side in a warm wall booth and shall have an inside surface composed of sheetrock or plaster on gypsum lath or metal lath. The thickness of the sheetrock or plaster shall not be less than $\frac{3}{8}$ in.

The bottom ground for the sheetrock shall consist of a wood board not more than 3 $\frac{5}{8}$ in wide, nailed to the studs at the floor level. In order to prevent destruction of the plaster wall when installing the test unit mounting brackets, a $\frac{3}{4}$ (minimum) x 1 $\frac{1}{2}$ x 36 in wood slat should be installed vertically on studs as shown in Figure C1. These wood slats should be used to fasten the test unit mounting brackets and can be replaced without damaging the

plaster wall. Use a mold release agent for easy removal and replacement on the three surfaces.

The room side of the ground and sheetrock shall be flush and there shall be no air leakage through or around the bottom ground.

The lower part of the wall shall be insulated with 3 ½ in thick blanket insulation or equivalent, laid between the studs and in contact with the sheetrock and extending from the floor to at least 12 in above the top of the highest unit to be tested as shown in Figure C1.

Note: It is permissible to build an interior false wall inside the test room or booth, with the construction of the front surface complying with the provisions of this standard and with 3 ½ in thick blanket insulation, or equivalent, between the permanent wall and the false wall. The height of this false wall shall be at least 12 in higher than the top of the highest unit to be tested.

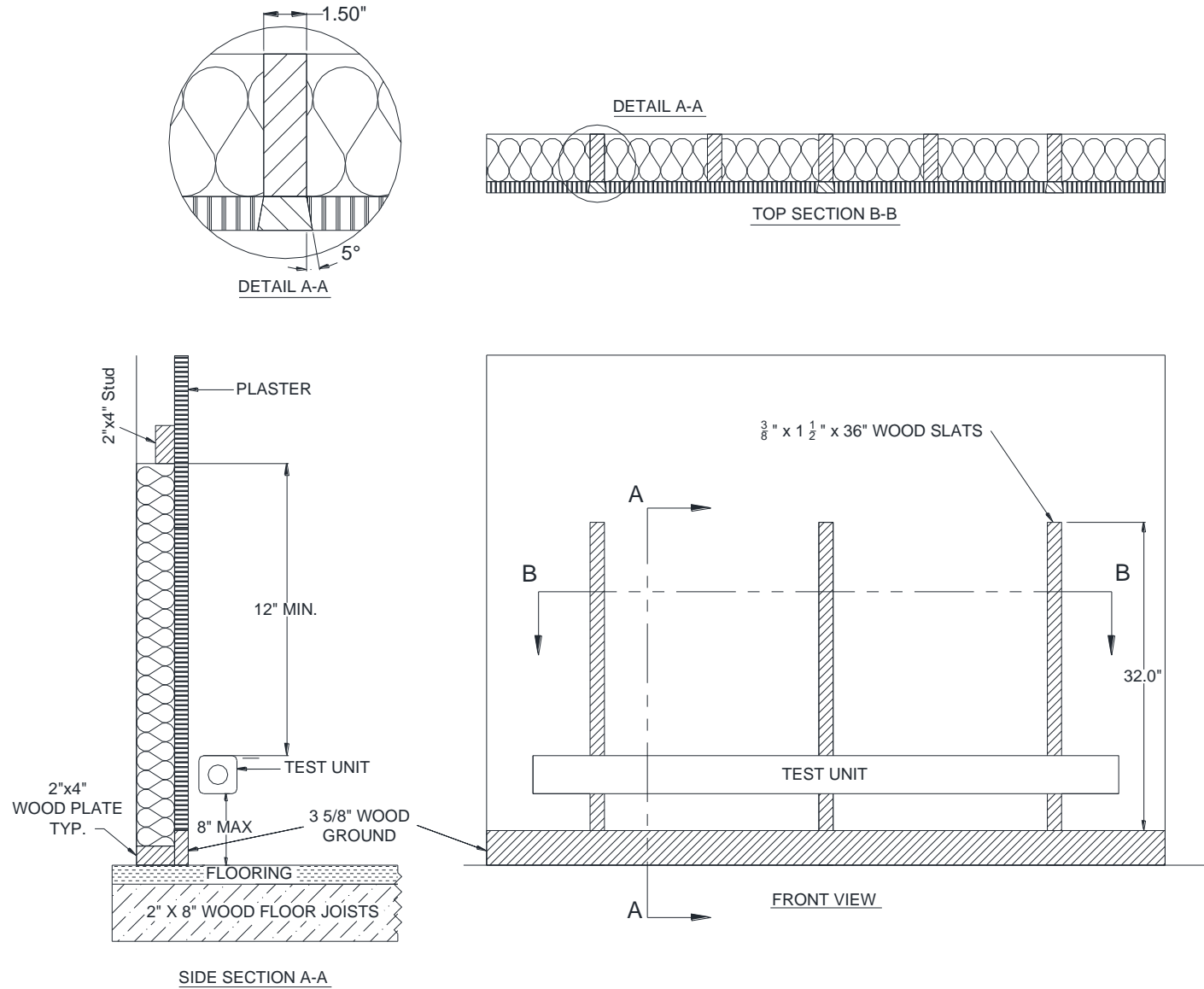

Figure C1. Test Unit Wall Construction

C3.2 *Thermocouple Locations for Temperature Measurements.*

C3.2.1 *Air Temperature Surrounding the Test Booth.* The air temperature measurements in the space surrounding the test booth shall be taken as specified in Section C3.2.1.1 and C3.2.1.2. Temperatures taken at each point shall not show a variation in excess of ± 3 °F during the course of a test. All temperatures shall be recorded on the test log sheet, CFTR-TR3.

C3.2.1.1 *Air Temperature Surrounding the Test Booth at the Rear Wall.* The air temperature at the rear wall shall be measured at the midpoint of the rear wall of the test booth, at a level of 30 in above the floor of the test booth, at a distance of 12 in from the rear wall (see Figure C2, Point A). The temperature at the rear wall shall be not less than 50 °F at any time during the test.

C3.2.1.2 *Air Temperature Surrounding the Test Booth at the Front Edge.* The air temperature shall be taken at the front edge of each side wall at a distance of 12 in from the wall and at two heights: 3 in and 60 in above the floor of the test booth (see Figure C2, Points B, C, D, E). The air temperatures at the front edge shall be taken at a distance of 3 in above the floor (see Figure C2, Points C and E) and at all times must be between T_a and (T_a minus 10 °F).

C3.2.2 *Air Temperature at the Center of the Room or Booth.* Temperature readings shall be taken in the center of the room or booth at levels of 3 in above the floor, as shown in Figure C2 at Points I, H, and G, respectively. Temperature readings shall also be measured at 3 in below the ceiling as shown in Figure C2, Point F.

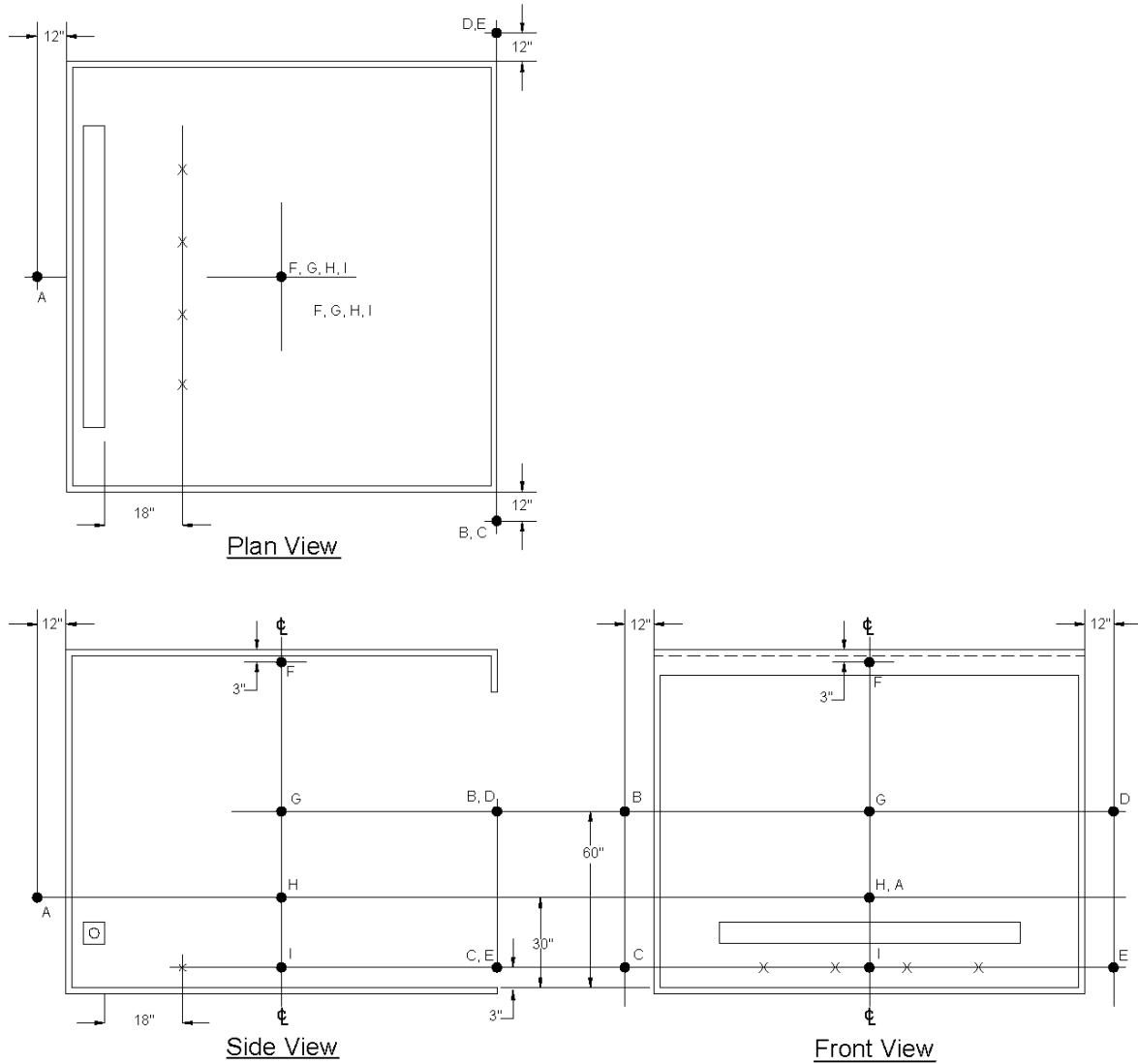

Section Reference	Measurement Description	Measurement Location(s)
C3.2.1.1	Air temperature surrounding the test booth at the rear wall.	Point A
C3.2.1.2	Air temperature surrounding the test booth at the front edge	Points B, C, D, and E
C3.2.2	Air temperature at the center of the room or booth.	Points F, G, H, and I
C3.2.3	Air temperature in front of the test unit.	Points X

Figure C2. Location of Thermometers/Thermocouples for Measuring Air Temperature

C3.2.3. Air Temperature in Front of the Test Unit. The air temperature in front of the test unit shall be measured 3 in above the floor at four or more points, spaced not more than 24 in apart throughout the length of the unit and 18 in in front of the unit, as shown in Figure C3. The end thermocouple or thermometer shall be 12 in from the ends of the unit, as shown in Figure C3.

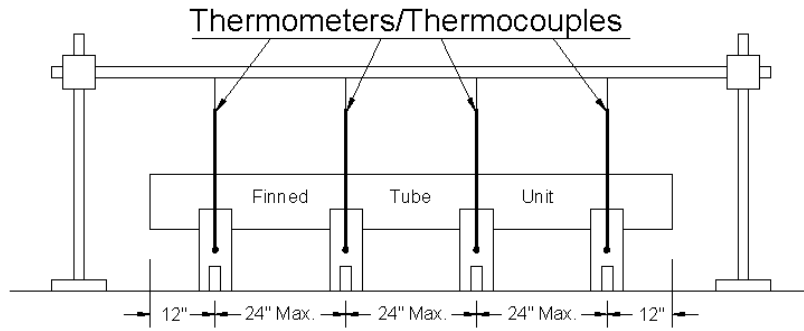

Figure C3. Location of Thermometers/Thermocouples in Front of the Test Unit

C3.2.3.1 Additional Requirements for Measuring Air Temperature in Front of the Test Unit. The thermocouple or thermometer used in the test shall be accurate within ± 0.5 °F. The sensitive end of thermocouple or thermometer shall not have a diameter greater than $\frac{5}{16}$ in. The last 2 in of the temperature sensitive end shall be shielded against radiation by bright metal shields of such construction as not to interfere with the airflow (see Figure C4 for suggested constructions).

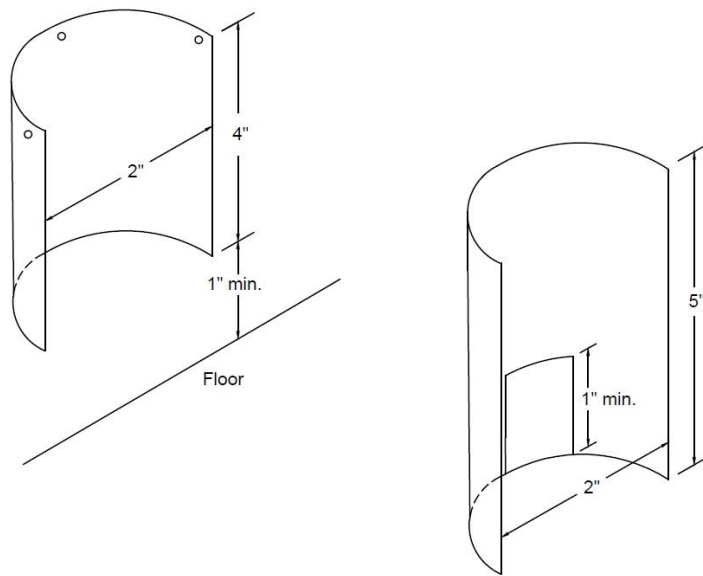

Figure C4. Suggested Construction of Thermometer/Thermocouple Shield of Bright Metal

C3.3 Test Equipment. Instruments which meet the minimum requirements shown in Table C1 shall be used.

Table C1. Equipment Accuracy Requirements			
Item	Minimum Instrument Accuracy	Minimum Instrument Resolution	Measurement Description
Resistance Temperature Detector (RTD)	± 0.25 °F	1 °F	Steam Supply Temperature
Precision Thermocouple	± 1 °F	1 °F	Air Temperature in front of the test unit
Thermocouple (Standard)	± 1 °F	1 °F	Air Temperature except in front of the test unit
Thermometer	± 1 °F	1 °F	Air Temperature in front of the test unit
Pressure Transducer or Gauge	± 0.01 psi	0.01 psi	Steam Pressure
Caliper	± 0.001 in	0.001 in	Fin Thickness, Nominal Tube Diameter
Measuring Tape	± 0.5%	1/32 in	Fin Height
Measuring Tape	± 0.25 in	0.25 in	Active Tube Length
Weighing Scale	± 0.5%	0.1 lb	Weight of Condensate

C3.3.1 Calibration. Instruments shall be calibrated to a recognized standard at regular intervals.

C4 *Test Setup*

C4.1 Installation of Test Unit and Piping. The Commercial Finned Tube shall be installed in accordance with the following requirements.

C4.1.1 Length of Test Units. Tests shall be run on finned tube elements having an Active Length not less than 7 ft. If the Active Length is different from the Total Length, the relationship between them shall be the same as specified in the manufacturer’s product literature.

C4.1.2 Location. The finned tube unit shall be installed along the wall of the test room that is insulated in accordance with Section C3.1.2.5. The distance from the end of the finned tube unit and the adjacent side walls of the room shall be at least 6 in.

C4.1.3 Mounting. The finned tube unit shall be mounted or hung in accordance with the manufacturer’s instructions. Hangers, brackets, and supports regularly furnished with the element shall be used. The distance from the floor to the top of the lowest element shall be not more than 12 in (see Figure C1), unless the manufacturer intends to specifically recommend a higher dimension, in which case the recommended height shall be used for the test.

C4.1.3.1 Pitch. The bare element or the finned tube unit shall be pitched down towards the condensate collection side at 1 in per 8 ft (See Figure C5).

C4.1.4 Supply Piping. The supply piping shall be insulated with a minimum insulation equivalent to a value of R-4 and of such size as to cause only a negligible pressure drop between pressure measuring device and the finned tube unit. The piping inside the test shall be kept to a minimum. (Figure C5 illustrates a suitable piping arrangement and the required pitch.)

C4.1.5 *Condensate Piping.* A two-pipe hookup shall be used. The condensate piping shall be connected to the lower tapping opposite the steam inlet of the finned tube unit. The pipe shall be insulated with a minimum insulation equivalent to R-4 and shall drain the condensate freely from the finned tube unit to a receptacle. Suitable seals shall be provided in the condensate piping to prevent steam from issuing from the end of the condensate piping. The condensate pipe shall terminate outside the test room or booth and be provided with an air vent. Steam which might escape from this vent shall be conducted outside the test room or booth. A covered container, if used, must be of such design that the return outlet has a continuous, unbroken, deep, water seal. (see Figure C5 for an illustration of a suitable piping arrangement.)

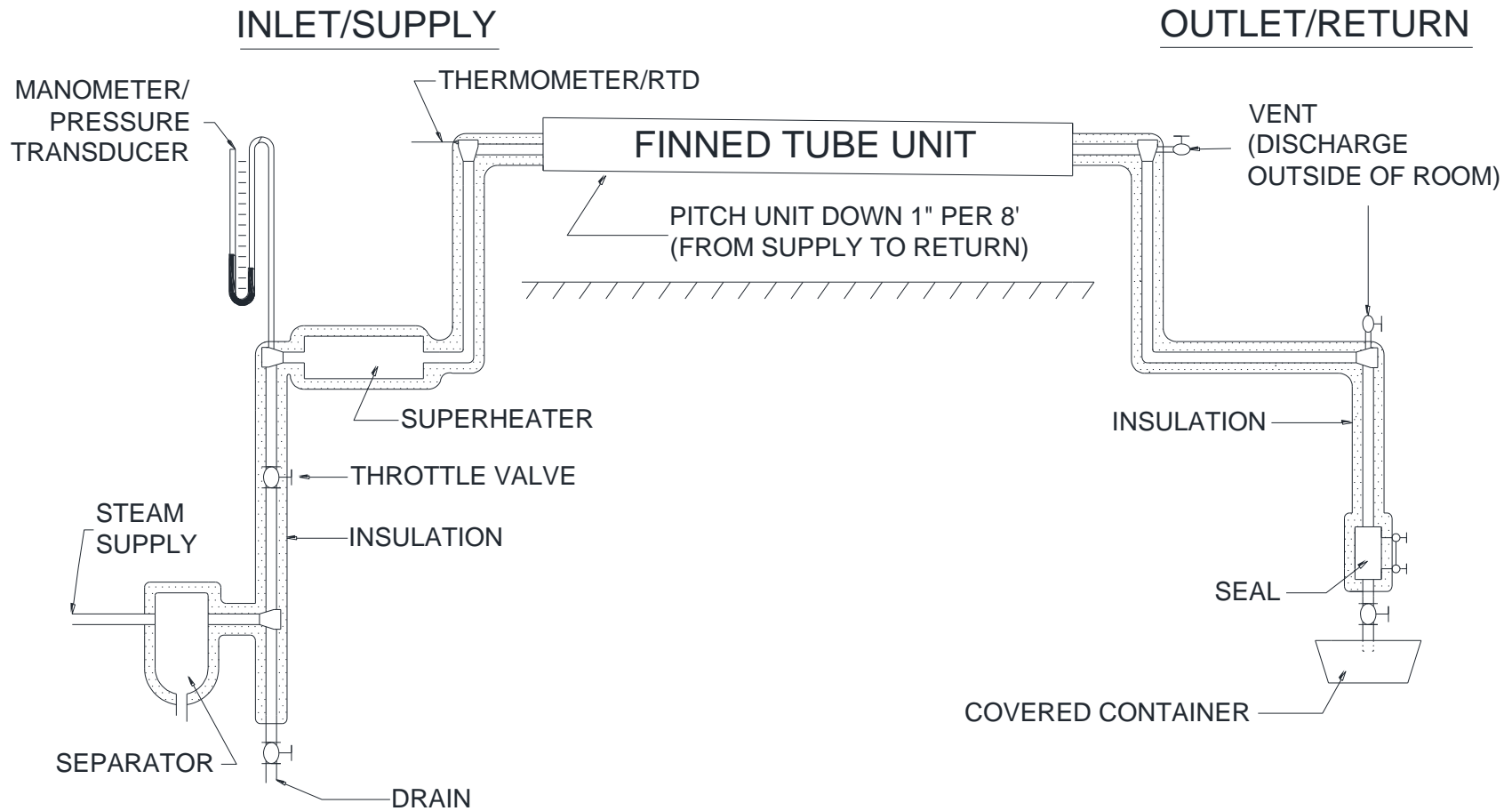
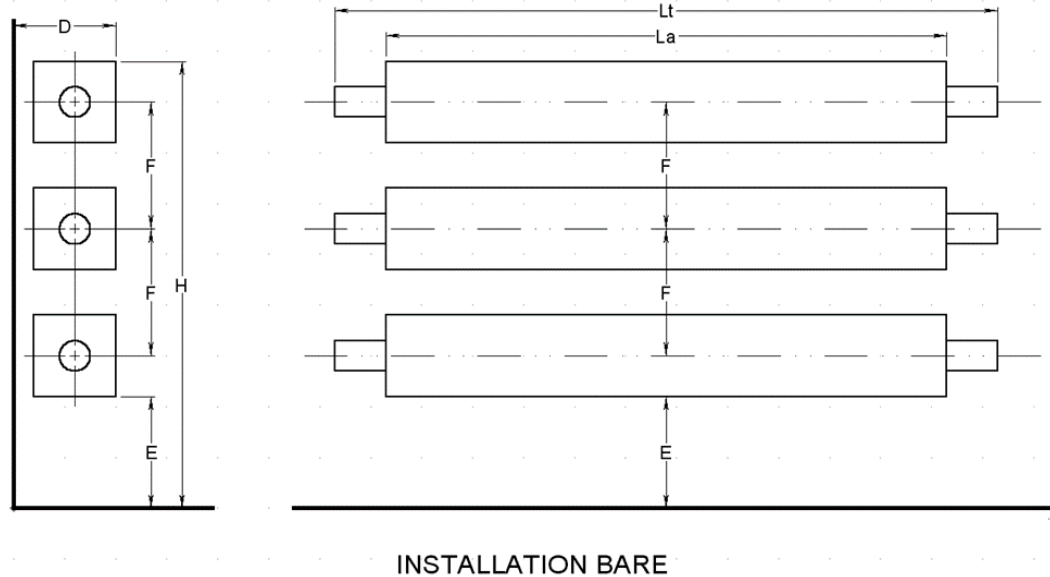

Figure C5. Suggested Methods and Equipment for Supplying Steam to the Finned Tube Unit and Measuring the Condensate

C4.1.5 Multiple Tiers. If the finned tube element is catalogued for installation in multiple tiers, tests shall be run with the distance between centers of the tiers (Dimension F) as specified by the manufacturer. If more than one center-to-center spacing is catalogued, tests shall be run for each such center-to-center spacing. This measurement shall be made at the mid-length of the units installed, but the catalogued minimum installation height shall be observed (see Figure C6).



Dimension	Description
D	Distance from wall to front of fins
E	Height to bottom of fins at center
F	Center to center of tiers
H	Installed height
L _a	Active length of element
L _t	Total length of element

Figure C6. Installation Bare Dimensions

C4.1.6 Covers or Enclosures. Covers or Enclosures shall be installed in accordance with the manufacturer’s instructions, using the supports or hangers regularly furnished. If end Enclosures are catalogued for the unit, they shall be installed during the test, or the ends closed by some other means at the point where the end Enclosure would normally be. The Installed Height for the test shall be that specified in the manufacturer’s product literature, but the catalogued minimum installation height shall be observed (see Figure C7).

C4.1.6.1 The highest point of the outlet opening of a front outlet Cover or Enclosure as installed (Figure C7, H_f); or

C4.1.6.2 The top-side of the horizontal opening of a top outlet Cover or Enclosure as installed (Figure C7, H_t); or

C4.1.6.3 The center of the free opening of an inclined outlet Cover or Enclosure as installed (Figure C7, H_i); or

C4.1.6.4 The top of the uppermost element for a bare finned tube element, or in an open-type grille (Figure C7, H). Also known as Mounting Height.

Note: A Cover or Enclosure with substantial portions of the outlet in both the front and the top is considered an inclined outlet Cover or Enclosure, with the angle of inclination determined by drawing a line between the back of the top outlet portion and the bottom of the front outlet portion.

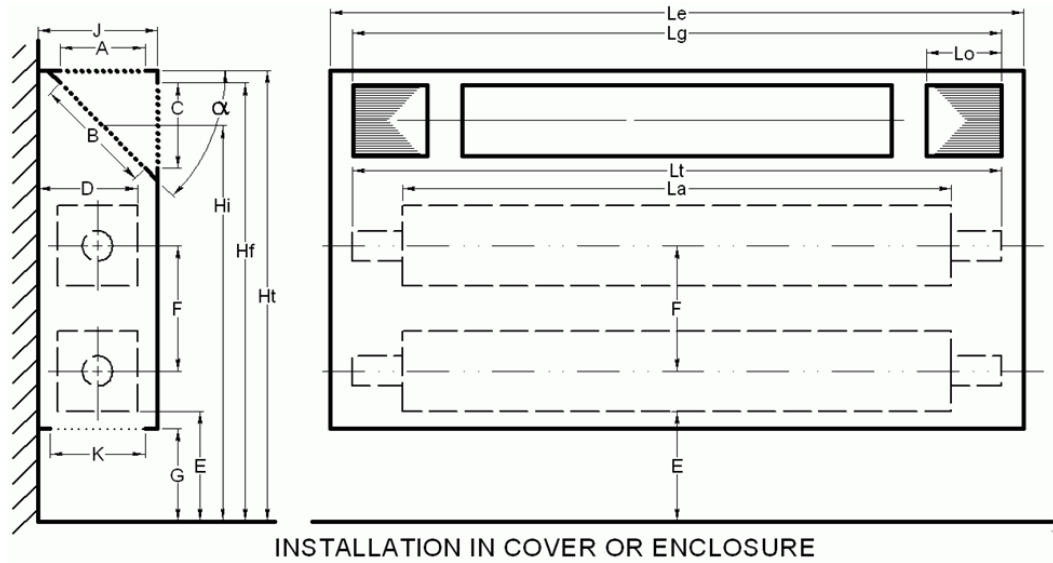

Dimension	Description
α	Inclination of outlet (if inclined)
A, B or C	Width of outlet
D	Distance from wall to front of fins
E	Height to bottom of fins at center
F	Center to center of tiers
G	Height of inlet
H_f	Installed height to the highest point of the outlet opening of a front outlet Cover or Enclosure as installed.
H_i	Installed Height to the center of the free opening of an inclined outlet Cover or Enclosure as installed
H_t	Installed Height to the top-side of the horizontal opening of a top outlet Cover or Enclosure as installed
J	Depth of enclosure
K	Width of inlet opening
L_a	Active length of element
L_e	Total length of enclosure
L_g	Length of outlet
L_o	Size of individual outlet section
L_t	Total length of element

Figure C7. Installation in Cover or Enclosure Dimensions

C5 *Test Procedure.*

C5.1 *Start of Test.* The test shall be started only after a state of equilibrium has been reached. Such a state of equilibrium may be considered to exist if, for a period of at least 30 minutes, the Air Temperature (T_a) does not vary more than 1 °F and the rate of condensation does not vary more than 3%. Actual readings for this equilibrium period shall be taken at 15 minute intervals and shall be recorded on the test log sheet.

C5.2 *Duration of Test.* The test shall be conducted for not less than 1 hour.

C5.3 *Steam Supply.* Steam shall be supplied to the finned tube unit at a saturated steam temperature corresponding to pressure (T_{s1}) as specified in Table 1 and shall be between 214 °F and 217 °F. The supply steam superheat temperature (T_{s2}) shall not be less than 2 °F nor more than 5 °F. The steam supply temperature (T_{s3}) shall be measured by an RTD directly exposed to the steam and located within 12 in of the finned tube unit. The absolute steam pressure (P_s) shall be measured by a pressure measuring device connected to the supply pipe.

C5.4. *Air Temperature.* The finned tube unit shall be tested with air temperatures (t_a) not less than 60 °F nor more than 75 °F.

C5.5 *Air Venting.* The finned tube unit shall be vented continuously during the test by suitable means and the expelled air, gases, and steam shall be discharged outside the test room or booth. The vent in the condensate line mentioned in Section C4.1.4, may be used for this purpose and it is recommended that the air vent hole be not larger than 0.03 in in diameter.

C5.6 *Temperature and Pressure Readings.*

C5.6.1. The supply steam superheat temperature (T_{s2}) and air temperature (T_a) shall be read at the beginning and at the end of each test. In addition, intermediate readings shall be taken every 15 minutes during the test. All readings of the supply steam superheat temperature (T_{s2}) shall conform to the limitations of Section C5.3, *Steam Supply*. The average of all temperatures shall be used for calculation.

C5.6.2 The Steam Supply Temperature (T_{s3}) shall not vary more than four-tenths degree (± 0.4 °F) during the test.

C5.6.3 The readings of the air temperature thermometers (T_a) shall not differ from one another by more than 3 °F at any time during the test and the readings of each thermometer shall not vary more than 1 °F during the test. The average temperatures (T_a) shall be used for calculation.

C5.6.4 The air temperatures surrounding the test booth or room during the test shall be those specified in Sections C3.2.1.

C5.6.5 The barometric pressure shall be read at the beginning and end of the test period to the nearest 0.02 in Hg.

C5.7 *Condensate.* The total condensate shall be collected and weighed. Two or more measurements of condensate should be made at every 15 minutes within the test time, and the condensation rate obtained on these measurements shall not vary more than three percent $\pm 3\%$.

C5.8 *No-Load Test.* A no-load test to determine the amount of steam which is condensed by the condensate piping, exclusive of the test unit, shall be made. This no-load test shall be run under the same rating conditions and following the same procedure as is provided in this Standard for a test on a finned tube unit. The no-load test shall be run for a minimum of two hours and the condensate collected per hour shall be deducted from the gross condensation of the finned tube unit before correcting to standard rating conditions.

Use C5.8.1 if no additional piping is required to conduct the no-load test. If additional piping is required use C5.8.2

C5.8.1 Move either the supply piping or condensate piping and condensate seal and join them using a direct connection. The condensate collected per hour will then represent the condensation rate under no-load correction (C_{nl}).

C5.8.2 If the piping is inflexible, substitute in place of the test unit a pipe of the same diameter and insulated in exactly the same manner as the condensate piping. Measure the substitute piping length and record the length of substitute piping.

Measure the permanent condensate piping length, which is the length of pipe from inlet thermometer to the condensate seal.

The gross condensation rate (R_g) shall be divided by the total length of pipe from inlet thermometer to condensate seal (Figure C5) and then multiplied by the permanent condensate piping length. This value will then represent the condensation rate under no-load correction (C_{nl}) as in (Section C5.8.1) above.

C6. *Test Data to be Recorded.*

C6.1 *CFTR Bare Element Features*

C6.1.1 *Dimensions.* The following information shall be recorded for CFTR bare element and installation dimensions.

- C6.1.1.1** Tube material
- C6.1.1.2** Nominal tube diameter, in
- C6.1.1.3** Fin material
- C6.1.1.4** Fin size (height, width, thickness), in
- C6.1.1.5** Finish of fin
- C6.1.1.6** Method of bonding
- C6.1.1.7** Catalog designation
- C6.1.1.8** Total length of element (L_t), (ft)
- C6.1.1.9** Active length of element (L_a), (ft)
- C6.1.1.10** Number of fins in tested length
- C6.1.1.11** Number of fins per foot
- C6.1.1.12** Number of tiers
- C6.1.1.13** Center to center distance of tiers (F), in
- C6.1.1.14** Installed height (H), in
- C6.1.1.15** Height of bottom of fins (E), in
- C6.1.1.16** Distance from wall to front of fins (D), in

C6.2 *CFTR Enclosure Features*

C6.2.1 *Steam Test Data.* The following steam test data shall be recorded. Data may be recorded using Form CFTR-TR1

- C6.2.1.1** Tested Height (installed), in
- C6.2.1.2** Tested Active Length of Finned Tube, ft
- C6.2.1.3** Total Length of Test Unit, ft
- C6.2.1.4** Barometric Pressure, in Hg or psi
- C6.2.1.5** Steam Supply Temperature (T_{s3}), °F
- C6.2.1.6** Absolute Steam Pressure (P_s), in Hg or psi
- C6.2.1.7** Saturated Steam Temperature corresponding to Pressure (T_{s1}), °F
- C6.2.1.8** Superheat, °F
- C6.2.1.9** Average Air Temperature, °F
- C6.2.1.10** Steam Temperature - Average Air Temperature, °F
- C6.2.1.11** Duration of Test, h
- C6.2.1.12** Total Weight of Condensate during test, lb
- C6.2.1.13** Gross Condensation Rate, lb/h
- C6.2.1.14** Condensation Rate Under No-Load Correction, lb/h
- C6.2.1.15** Net Condensation Rate, lb/h

C6.2.1.16 Latent Heat of Steam (h_{fg}), Btu/lb

C7. *Calculations.*

C7.1 *Gross Condensation Rate.* The gross condensation rate shall be determined by Equation C1

$$R_g = \frac{W_c}{t} \quad \text{C1}$$

where:

- R_g = Gross Condensation Rate, lb/h
- t = Duration of Test, h
- W_c = Total Weight of Condensate during test, lb

C7.2 *Condensation Rate Under No-Load Correction.* The no-load correction for Section C5.8.2 shall be determined by Equation C2

$$R_{nl} = R_g \cdot \frac{L_c}{L_{sp} + L_c} \quad \text{C2}$$

where:

- L_c = Length of Permanent Condensate Piping, in
- L_{sp} = Length of Substitute Piping, in
- R_{nl} = Condensation Rate under No-Load Correction, lb/h
- R_g = Gross Condensation Rate, lb/h

C7.3 *Net Condensation Rate.* The net condensation rate shall be determined by Equation C3

$$R_{net} = R_g - R_{nl} \quad \text{C3}$$

where:

- R_g = Gross Condensation Rate, lb/h
- R_{net} = Net Condensation Rate, lb/h
- R_{nl} = Condensation Rate under No-Load Correction, lb/h

C7.4 *Condensation Capacity for Rating Conditions.* The condensation capacity of a finned tube unit for rating conditions shall be determined by Equation C4:

$$H_c = \frac{R_g \cdot h_{fg}}{L_a} \quad \text{C4}$$

where:

- H_c = Condensation capacity for test conditions, Btu/h·ft
- h_{fg} = Latent heat of evaporation steam corresponding to the saturated steam temperature in the finned tube unit during test. (Table C2 - Properties of Water). The reading of the pressure gauge described in Section C6.3, *Steam Supply*, shall be used to determine the saturated steam temperature inside the finned tube unit, Btu/lb.
- L_a = Active length of finned tube unit, ft
- R_g = Gross condensation rate, lb/h

TABLE C2. Properties of Water			
Temperature °F	Absolute Steam Pressure		Latent Heat (h _{fg}) Btu/lb
	lb / in ²	in Hg	
214.0	15.289	31.129	969.0
214.1	15.320	31.191	968.9
214.2	15.350	31.254	968.9
214.3	15.381	31.316	968.8
214.4	15.411	31.378	968.8
214.5	15.442	31.441	968.7
214.6	15.473	31.503	968.6
214.7	15.503	31.565	968.6
214.8	15.534	31.627	968.5
214.9	15.564	31.690	968.5
215.0	15.595	31.754	968.4
215.1	15.626	31.814	968.3
215.2	15.656	31.877	968.3
215.3	15.687	31.939	968.2
215.4	15.717	32.001	968.2
215.5	15.748	32.064	968.1
215.6	15.779	32.126	968.0
215.7	15.809	32.188	968.0
215.8	15.840	32.250	967.9
215.9	15.870	32.313	967.9
216.0	15.901	32.375	967.8
216.1	15.933	32.439	967.7
216.2	15.964	32.504	967.7
216.3	15.996	32.568	967.6
216.4	16.027	32.632	967.6
216.5	16.059	32.697	967.5
216.6	16.090	32.761	967.4
216.7	16.122	32.825	967.4
216.8	16.154	32.889	967.3
216.9	16.185	32.954	967.3
217.0	16.217	33.018	967.2

Note: As published from "Thermodynamic Properties of Steam" by Joseph H. Keenan and Frederick G. Keyes

C7.5 Correction Factors for Standard Rating Conditions.

C7.5.1 Correction for Steam Temperature to Air Temperature Difference. The correction factor for converting the capacity obtained at the steam and air temperatures during the test to the standard steam and air temperature shall be determined by Equation C5

$$C_s = \left[\frac{215-65}{T_{s1}-T_a} \right]^{1.6} = \left[\frac{150}{T_{s1}-T_a} \right]^{1.6} \tag{C5}$$

where:

- C_s = Correction factor for steam temperature to air temperature difference, unitless
- T_a = (Average) Air temperature during test, °F
- T_{s1} = Saturated steam temperature corresponding to pressure, °F

C7.5.2 Correction for Barometric Pressure. The correction factor (C_b) for average observed test barometric pressure shall be determined by Equation C6 or C7

$$C_b = \left[\frac{29.921}{P_b} \right]^{0.886} \text{ for copper / aluminum units} \quad \text{C6}$$

$$C_b = \left[\frac{29.921}{P_b} \right]^{0.454} \text{ for ferrous units} \quad \text{C7}$$

where:

C_b = Correction for barometric pressure, unitless
 P_b = Barometric pressure, in Hg

C7.6 *Condensation Capacity For Standard Rating Conditions.* The condensation capacity for standard rating conditions (H_s) shall be determined by Equation C8

$$H_s = C_s \cdot C_b \cdot H_c \quad \text{C8}$$

where:

C_b = Correction for barometric pressure, unitless.
 C_s = Correction for steam temperature to air temperature difference, unitless.
 H_c = Condensation capacity for rating conditions, Btu/h·ft
 H_s = Condensation capacity for standard rating conditions, Btu/h·ft

APPENDIX D. SOURCES OF ERROR IN STEAM FINNED TUBE UNIT TEST PROCEDURES - INFORMATIVE

D1. The major sources of error in the test procedure are as follows:

- D1.1** Entrained water brought into the finned tube unit with the steam.
- D1.2** Improper measuring of condensate caused by heat loss of supply and condensate piping.
- D1.3** Loss of condensate during the collection process by spillage or evaporation.
- D1.4** Incomplete venting of the finned tube unit. This is particularly true of multiple row assemblies which are more difficult to vent.
- D1.5** Excessive air currents inside test room or booth due to disturbances.
- D1.6** Wet or insufficient insulation on piping.
- D1.7** Incorrect calibration of thermometers or other temperature measuring devices and scales.
- D1.8** Starting test before equilibrium is obtained.
- D1.9** Inaccurate air temperature readings (t_a) due to improper shielding.
- D1.10** Improper drainage of multiple row assemblies due to improper pitch of each row.

APPENDIX E – TABLES FOR DETERMINING RATINGS FOR MULTIPLE TIER ELEMENTS OF VARIOUS CFTR PRODUCT TYPES - INFORMATIVE

INDEX TO TABLE E

Condensation Capacity for Multiple Tier Bare Units

	2-Tiers	3-Tiers
2 in Internal Pipe Size (IPS) – 4-1/4 in Steel – Painted	TABLE E1	TABLE E2
1-1/4 in IPS – 4-1/4 in Steel – Painted	TABLE E3	TABLE E4
1-1/4 in IPS – 3-1/4 in Steel – Painted	TABLE E5	TABLE E6
1-1/4 in Copper – 4-1/4 in Aluminum – Unpainted	TABLE E7	TABLE E8
1-1/4 in Copper – 4-1/4 in Aluminum – Painted	TABLE E9	TABLE E10
1-1/4 in Copper – 3-1/4 in Aluminum – Unpainted	TABLE E11	TABLE E12
1-1/4 in Copper – 3-1/4 in Aluminum – Painted	TABLE E13	TABLE E14

HOW TO USE TABLE E

1. Select the correct table from the Index to TABLE E that applies to the unit in question.
2. Enter the left-hand column at the value closest to the one-tier bare Condensation Capacity for Standard Rating Conditions (H_s). Proceed to the right to the column headed by the correct E (or H) and D dimensions and read the two or three-tier capacity.
3. Rules governing the use of Table E.
 - (a) E dimensions can be interpolated.
 - (b) D dimensions can be interpolated. In cases where the D value is not more than 1/4 in greater than the last column, the last column may be used.
 - (c) Metallic coated units are not within the scope of these tables.

TABLE E1. Condensation Capacity of 2 in IPS 4-1/4 in Steel Units - Bare (Painted), Two Tiers									
One Tier	TWO TIERS (F = 6 in)								
	E = 3-3/4 (H=14)			E = 5-3/4 (H=16)			E = 7-3/4 (H=18)		
	D = 4-1/2	D = 4-3/4	D = 5	D = 4-1/2	D = 4-3/4	D = 5	D = 4-1/2	D = 4-3/4	D = 5
840	1526	1548	1571	1521	1544	1566	1514	1535	1558
850	1542	1564	1587	1537	1559	1582	1528	1550	1574
860	1557	1580	1603	1552	1574	1598	1543	1565	1589
870	1573	1596	1619	1568	1589	1614	1558	1580	1605
880	1588	1611	1635	1583	1605	1630	1573	1595	1620
890	1603	1626	1651	1597	1620	1645	1587	1610	1635
900	1618	1641	1667	1611	1635	1660	1601	1625	1650
910	1633	1656	1682	1626	1650	1675	1615	1639	1665
920	1647	1671	1697	1640	1664	1691	1629	1654	1680
930	1662	1686	1712	1654	1679	1706	1643	1669	1694
940	1676	1700	1727	1668	1693	1720	1657	1683	1709
950	1690	1715	1742	1682	1708	1735	1671	1696	1723
960	1704	1729	1757	1696	1722	1749	1684	1709	1737
970	1718	1744	1771	1710	1736	1763	1697	1722	1751
980	1732	1758	1786	1724	1749	1777	1709	1735	1764
990	1745	1772	1800	1736	1762	1791	1721	1747	1777
1000	1759	1785	1814	1749	1775	1805	1733	1760	1790
1010	1772	1798	1827	1761	1789	1818	1744	1773	1803
1020	1784	1811	1841	1773	1801	1831	1755	1785	1816
1030	1796	1823	1854	1785	1813	1844	1765	1797	1828
1040	1808	1836	1867	1796	1825	1856	1776	1809	1840
1050	1820	1848	1880	1807	1838	1869	1786	1819	1852
1060	1831	1860	1892	1817	1850	1882	1795	1828	1863
1070	1841	1873	1905	1827	1861	1893	1803	1838	1875
1080	1851	1885	1917	1837	1871	1905	1812	1847	1885
1090	1861	1896	1928	1845	1881	1916	1820	1855	1894
1100	1871	1905	1940	1854	1890	1927	1827	1863	1904
1110	1879	1914	1951	1863	1898	1938	1834	1871	1913
1120	1887	1923	1962	1871	1906	1947	1839	1879	1923
1130	1896	1932	1973	1878	1914	1956	1843	1886	1932
1140	1904	1940	1982	1883	1922	1965	1846	1892	1939
1150	1911	1948	1991	1888	1930	1975	1846	1898	1946
1160	1916	1956	2000	1891	1936	1984	1843	1904	1951
1170	1921	1963	2009	1894	1942	1991	1837	1908	1956
1180	1924	1969	2018	1894	1948	1997	—	—	—
1190	1927	1975	2024	1891	1953	2002	—	—	—
1200	1926	1981	2030	1884	1957	2006	—	—	—
1210	1922	1986	2035	—	—	—	—	—	—
1220	1915	1990	2040	—	—	—	—	—	—

Range of Dimensions:

Fin size: $\pm 1/32$ in tolerance
 Fin thickness: 0.021 to 0.045 in steel
 Fin spacing: 23 to 44 fins per foot
 Center-to-center tier spacing (F) 6 in to 6-3/8 in

TABLE E2. Condensation Capacity of 2 in IPS 4-1/4 in Steel Units - Bare (Painted), Three Tiers									
One Tier	THREE TIERS (F = 6 in)								
	E = 3-3/4 (H=20)			E = 5-3/4 (H=22)			E = 7-3/4 (H=24)		
	D = 4-1/2	D = 4-3/4	D = 5	D = 4-1/2	D = 4-3/4	D = 5	D = 4-1/2	D = 4-3/4	D = 5
840	2128	2171	2209	2113	2156	2197	2090	2134	2174
850	2145	2189	2229	2130	2174	2215	2107	2152	2193
860	2163	2207	2249	2147	2193	2233	2123	2170	2212
870	2180	2225	2268	2164	2211	2252	2139	2188	2230
880	2197	2243	2276	2181	2228	2270	2156	2205	2248
890	2214	2261	2304	2197	2246	2289	2172	2222	2266
900	2231	2279	2322	2213	2264	2307	2188	2239	2283
910	2247	2297	2340	2229	2281	2325	2203	2256	2300
920	2262	2314	2358	2245	2297	2342	2218	2272	2317
930	2279	2331	2376	2261	2314	2359	2233	2287	2334
940	2294	2347	2393	2276	2330	2376	2248	2302	2351
950	2309	2364	2410	2291	2346	2393	2262	2318	2367
960	2324	2380	2427	2305	2361	2410	2275	2333	2383
970	2339	2395	2443	2319	2376	2426	2289	2347	2399
980	2353	2410	2460	2332	2391	2442	2302	2362	2414
990	2367	2425	2476	2346	2406	2458	2316	2376	2428
1000	2380	2440	2492	2360	2420	2473	2328	2390	2444
1010	2394	2454	2508	2373	2434	2488	2340	2404	2458
1020	2407	2468	2522	2386	2448	2502	2352	2417	2472
1030	2420	2482	2537	2398	2462	2517	2363	2430	2486
1040	2433	2496	2551	2410	2475	2531	2373	2443	2500
1050	2444	2510	2566	2421	2488	2545	2383	2455	2514
1060	2456	2523	2580	2432	2500	2559	2393	2467	2526
1070	2467	2536	2594	2442	2513	2572	2402	2478	2538
1080	2478	2548	2607	2452	2525	2585	2411	2488	2550
1090	2488	2560	2620	2462	2536	2597	2415	2497	2562
1100	2498	2572	2633	2470	2548	2609	2419	2506	2574
1110	2507	2583	2645	2476	2557	2621	2421	2516	2585
1120	2515	2594	2657	2481	2566	2633	2423	2525	2596
1130	2522	2604	2668	2485	2575	2644	2423	2533	2606
1140	2527	2612	2679	2486	2584	2655	2419	2540	2615
1150	2529	2620	2691	2487	2593	2666	2409	2545	2624
1160	2530	2629	2702	2487	2601	2675	2390	2550	2632
1170	2531	2638	2712	2483	2607	2684	2361	2554	2640
1180	2530	2646	2721	2472	2611	2693	—	—	—
1190	2525	2651	2730	2451	2616	2700	—	—	—
1200	2514	2656	2738	2422	2620	2707	—	—	—
1210	2492	2660	2745	—	—	—	—	—	—
1220	2462	2663	2752	—	—	—	—	—	—

Range of Dimensions:

Fin size: ± 1/32 in tolerance
 Fin thickness: 0.021 to 0.045 in steel
 Fin spacing: 23 to 44 fins per foot
 Center-to-center tier spacing (F) 6 in to 6-3/8 in

TABLE E3. Condensation Capacity of 1-1/4 in IPS 4-1/4 in Steel Units - Bare (Painted), Two Tiers									
One Tier	TWO TIERS (F = 6 in)								
	E = 3-3/4 (H=14)			E = 5-3/4 (H=16)			E = 7-3/4 (H=18)		
	D = 4-1/2	D = 4-3/4	D = 5	D = 4-1/2	D = 4-3/4	D = 5	D = 4-1/2	D = 4-3/4	D = 5
1000	1796	1822	1850	1787	1813	1841	1772	1797	1826
1010	1811	1837	1865	1801	1827	1856	1786	1811	1839
1020	1826	1852	1880	1815	1841	1871	1799	1825	1853
1030	1840	1866	1895	1828	1855	1885	1811	1838	1866
1040	1853	1881	1909	1842	1870	1899	1823	1851	1880
1050	1867	1895	1924	1855	1884	1913	1835	1864	1894
1060	1880	1908	1938	1869	1897	1927	1848	1876	1908
1070	1894	1922	1951	1882	1910	1941	1860	1889	1921
1080	1907	1935	1965	1894	1922	1954	1871	1901	1933
1090	1920	1948	1978	1906	1935	1967	1883	1913	1946
1100	1933	1961	1992	1918	1947	1980	1894	1925	1958
1110	1945	1974	2005	1929	1959	1992	1905	1936	1969
1120	1957	1986	2018	1941	1971	2005	1914	1948	1981
1130	1968	1998	2031	1952	1983	2017	1923	1957	1992
1140	1980	2010	2043	1962	1995	2029	1932	1965	2003
1150	1991	2021	2055	1971	2007	2041	1939	1973	2014
1160	2002	2033	2067	1981	2017	2052	1946	1982	2024
1170	2011	2045	2079	1990	2026	2063	1953	1991	2034
1180	2020	2057	2091	1998	2034	2074	1960	1999	2044
1190	2029	2066	2103	2006	2043	2085	1965	2008	2052
1200	2038	2074	2112	2014	2052	2095	1969	2015	2059
1210	2046	2081	2121	2021	2059	2103	1973	2021	2067
1220	2054	2089	2131	2028	2067	2112	1976	2026	2074
1230	2060	2096	2140	2032	2074	2120	1977	2031	2081
1240	2066	2103	2149	2036	2080	2129	1974	2036	2087
1250	2071	2111	2158	2038	2086	2138	1965	2039	2091
1260	2076	2118	2167	2040	2092	2144	1955	2042	2095
1270	2080	2123	2174	2038	2097	2149	—	—	—
1280	2083	2127	2179	2034	2101	2153	—	—	—
1290	2083	2131	2184	2025	2104	2167	—	—	—
1300	2083	2135	2189	2003	2106	2161	—	—	—
1310	2076	2138	2194	—	—	—	—	—	—
1320	2072	2140	2199	—	—	—	—	—	—

Range of Dimensions:

Fin size: ± 1/32 in tolerance
 Fin thickness: 0.021 to 0.045 in steel
 Fin spacing: 23 to 44 fins per foot
 Center-to-center tier spacing (F) 6 in to 6-3/8 in

TABLE E4. Condensation Capacity of 1-1/4 in IPS 4-1/4 in Steel Units - Bare (Painted), Three Tiers									
One Tier	THREE TIERS (F = 6 in)								
	E = 3-3/4 (H=20)			E = 5-3/4 (H=22)			E = 7-3/4 (H=24)		
	D = 4-1/2	D = 4-3/4	D = 5	D = 4-1/2	D = 4-3/4	D = 5	D = 4-1/2	D = 4-3/4	D = 5
1000	2476	2528	2576	2450	2506	2555	2412	2469	2520
1010	2490	2544	2593	2465	2522	2572	2426	2484	2536
1020	2505	2560	2610	2480	2538	2588	2439	2499	2551
1030	2519	2576	2627	2494	2553	2604	2452	2513	2566
1040	2533	2592	2643	2507	2568	2620	2465	2527	2581
1050	2547	2607	2659	2521	2582	2636	2477	2541	2596
1060	2561	2622	2675	2534	2596	2651	2490	2555	2610
1070	2574	2637	2692	2547	2610	2666	2503	2568	2624
1080	2588	2652	2708	2560	2624	2683	2514	2581	2638
1090	2601	2667	2723	2572	2638	2696	2525	2594	2652
1100	2614	2681	2737	2584	2651	2709	2536	2607	2666
1110	2626	2694	2751	2596	2664	2723	2546	2620	2679
1120	2639	2707	2764	2607	2677	2737	2556	2631	2692
1130	2651	2720	2778	2618	2689	2750	2566	2642	2705
1140	2663	2733	2791	2629	2701	2763	2575	2653	2718
1150	2674	2745	2804	2638	2713	2776	2582	2663	2729
1160	2683	2757	2816	2647	2725	2789	2588	2673	2740
1170	2692	2769	2828	2657	2735	2801	2592	2682	2751
1180	2702	2781	2840	2665	2746	2812	2595	2690	2762
1190	2711	2792	2852	2672	2756	2823	2595	2699	2772
1200	2718	2801	2864	2678	2765	2833	2596	2707	2782
1210	2725	2810	2876	2681	2772	2844	2594	2713	2790
1220	2731	2818	2888	2683	2779	2855	2589	2718	2799
1230	2737	2826	2899	2683	2787	2865	2578	2723	2807
1240	2738	2833	2910	2682	2795	2874	2558	2728	2814
1250	2739	2840	2920	2680	2803	2883	2525	2731	2820
1260	2735	2846	2928	2674	2808	2891	2482	2733	2826
1270	2731	2852	2936	2661	2811	2898	—	—	—
1280	2726	2856	2944	2637	2813	2904	—	—	—
1290	2715	2862	2950	2603	2816	2910	—	—	—
1300	2695	2867	2956	2558	2818	2915	—	—	—
1310	2659	2869	2961	—	—	—	—	—	—
1320	2611	2868	2963	—	—	—	—	—	—

Range of Dimensions:

Fin size: ± 1/32 in tolerance
 Fin thickness: 0.021 to 0.045 in steel
 Fin spacing: 23 to 44 fins per foot
 Center-to-center tier spacing (F) 6 in to 6-3/8 in

TABLE E5. Condensation Capacity of 1-1/4 in IPS 3-1/4 in Steel Units - Bare (Painted), Two Tiers									
One Tier	TWO TIERS (F = 6 in)								
	E = 4-3/4 (H=14)			E = 6-3/4 (H=16)			E = 8-3/4 (H=18)		
	D = 3-1/2	D = 3-3/4	D = 4	D = 3-1/2	D = 3-3/4	D = 4	D = 3-1/2	D = 3-3/4	D = 4
650	1205	1223	1236	1203	1220	1235	1198	1216	1230
660	1221	1239	1254	1219	1237	1252	1213	1232	1247
670	1237	1257	1271	1235	1253	1268	1229	1248	1264
680	1253	1272	1287	1250	1269	1285	1244	1263	1280
690	1268	1288	1304	1265	1285	1301	1260	1279	1296
700	1284	1303	1320	1281	1301	1317	1275	1294	1312
710	1299	1319	1336	1296	1316	1333	1290	1309	1327
720	1314	1335	1352	1311	1331	1349	1304	1323	1343
730	1329	1350	1368	1326	1345	1364	1318	1338	1358
740	1343	1365	1383	1340	1359	1380	1333	1353	1373
750	1358	1379	1399	1355	1374	1395	1348	1367	1388
760	1373	1393	1414	1370	1389	1410	1362	1381	1402
770	1388	1407	1428	1384	1403	1425	1375	1395	1417
780	1402	1421	1443	1398	1417	1439	1388	1409	1431
790	1416	1435	1458	1411	1432	1453	1401	1423	1444
800	1429	1449	1472	1424	1445	1467	1413	1435	1458
810	1442	1463	1486	1436	1457	1481	1424	1447	1470
820	1454	1475	1499	1448	1469	1491	1436	1459	1482
830	1466	1487	1512	1459	1481	1506	1447	1470	1494
840	1477	1499	1524	1471	1494	1518	1458	1481	1506
850	1488	1521	1536	1482	1505	1530	1469	1492	1518
860	1499	1523	1548	1493	1516	1542	1478	1503	1530
870	1510	1534	1560	1503	1527	1554	1487	1513	1540
880	1521	1545	1572	1513	1538	1564	1495	1522	1549
890	1530	1555	1582	1521	1548	1574	1501	1529	1558
900	1538	1565	1592	1529	1556	1584	1508	1536	1567
910	1546	1573	1602	1535	1563	1593	—	—	—
920	1552	1581	1611	1541	1570	1602	—	—	—
930	1558	1588	1619	—	—	—	—	—	—

Range of Dimensions:

- Fin size: $\pm 1/32$ in tolerance
- Fin thickness: 0.021 to 0.045 in steel
- Fin spacing: 23 to 44 fins per foot
- Center-to-center tier spacing (F) 6 in to 6-3/8 in

TABLE E6. Condensation Capacity of 1-1/4 in IPS 3-1/4 in Steel Units - Bare (Painted), Three Tiers									
One Tier	THREE TIERS (F = 6 in)								
	E = 4-3/4 (H=20)			E = 6-3/4 (H=22)			E = 8-3/4 (H=24)		
	D = 3-1/2	D = 3-3/4	D = 4	D = 3-1/2	D = 3-3/4	D = 4	D = 3-1/2	D = 3-3/4	D = 4
650	1724	1754	1782	1715	1744	1773	1699	1728	1756
660	1742	1772	1800	1733	1763	1791	1717	1746	1775
670	1760	1790	1818	1751	1781	1810	1734	1765	1795
680	1778	1808	1837	1769	1799	1829	1751	1784	1814
690	1795	1826	1856	1786	1817	1849	1766	1802	1833
700	1813	1844	1872	1803	1836	1868	1781	1819	1851
710	1828	1862	1898	1818	1852	1886	1796	1834	1867
720	1843	1880	1914	1832	1868	1904	1811	1849	1883
730	1858	1897	1930	1847	1884	1920	1825	1864	1899
740	1872	1911	1946	1861	1900	1936	1840	1880	1915
750	1886	1926	1961	1875	1916	1952	1855	1896	1931
760	1900	1941	1977	1889	1932	1968	1870	1911	1947
770	1914	1954	1993	1904	1948	1982	1883	1925	1962
780	1929	1976	2008	1919	1962	1999	1896	1939	1978
790	1943	1988	2024	1932	1975	2013	1909	1953	1994
800	1956	2000	2040	1944	1989	2030	1921	1966	2007
810	1968	2013	2056	1957	2003	2044	1932	1978	2019
820	1981	2025	2074	1969	2016	2057	1943	1990	2031
830	1993	2038	2084	1979	2027	2069	1953	2002	2044
840	2004	2051	2094	1990	2039	2081	1962	2013	2056
850	2015	2063	2106	2000	2050	2093	1970	2024	2069
860	2024	2074	2118	2009	2061	2105	1977	2035	2081
870	2032	2084	2130	2017	2071	2118	1984	2044	2092
880	2039	2094	2142	2025	2081	2130	1991	2052	2102
890	2047	2105	2154	2031	2091	2140	1997	2060	2111
900	2054	2114	2165	2037	2099	2150	2001	2066	2119
910	2059	2122	2174	2042	2107	2159	—	—	—
920	2064	2130	2182	2045	2111	2166	—	—	—
930	2067	2134	2189	—	—	—	—	—	—

Range of Dimensions:

Fin size: ± 1/32 in tolerance
 Fin thickness: 0.021 to 0.045 in steel
 Fin spacing: 23 to 44 fins per foot
 Center-to-center tier spacing (F) 6 in to 6-3/8 in

TABLE E7. Condensation Capacity of 1-1/4 in Copper 4-1/4 in Aluminum Units – Bare (Unpainted), Two Tiers									
One Tier	TWO TIERS (F = 6 in)								
	E = 3-3/4 (H=14)			E = 5-3/4 (H=16)			E = 7-3/4 (H=18)		
	D = 4-1/2	D = 4-3/4	D = 5	D = 4-1/2	D = 4-3/4	D = 5	D = 4-1/2	D = 4-3/4	D = 5
1150	2056	2086	2117	2047	2077	2108	2032	2062	2094
1160	2069	2100	2131	2059	2090	2122	2045	2075	2108
1170	2083	2113	2145	2072	2103	2135	2058	2088	2121
1180	2095	2126	2158	2085	2116	2149	2070	2100	2135
1190	2107	2139	2172	2098	2129	2162	2081	2112	2148
1200	2120	2152	2185	2111	2142	2176	2092	2124	2160
1210	2133	2165	2199	2122	2154	2189	2103	2136	2172
1220	2146	2177	2212	2133	2166	2202	2114	2148	2184
1230	2157	2189	2225	2144	2177	2214	2125	2159	2196
1240	2168	2201	2238	2155	2189	2226	2135	2170	2208
1250	2179	2213	2250	2166	2200	2238	2144	2180	2219
1260	2190	2224	2262	2177	2211	2250	2153	2190	2230
1270	2201	2235	2274	2187	2222	2261	2162	2199	2240
1280	2211	2246	2285	2195	2232	2272	2170	2207	2250
1290	2221	2257	2296	2204	2242	2283	2176	2215	2260
1300	2230	2267	2307	2212	2250	2293	2181	2223	2269
1310	2239	2277	2318	2220	2258	2303	2186	2230	2277
1320	2247	2286	2328	2226	2265	2313	2191	2237	2285
1330	2254	2293	2338	2231	2273	2321	2196	2244	2292
1340	2259	2302	2348	2236	2281	2329	2199	2250	2299
1350	2264	2309	2356	2241	2288	2337	2201	2255	2306
1360	2269	2315	2364	2245	2294	2344	2202	2258	2312
1370	2274	2322	2371	2248	2300	2351	2200	2261	2317
1380	2278	2328	2378	2249	2304	2358	2194	2264	2321
1390	2281	2334	2385	2250	2307	2364	2182	2266	2324
1400	2282	2338	2392	2248	2310	2369	2163	2268	2327
1410	2283	2341	2398	2242	2313	2372	2122	2267	2329
1420	2281	2344	2403	2229	2316	2374	2038	2265	2320
1430	2274	2347	2406	2209	2317	2376	—	—	—
1440	2261	2349	2408	2167	2316	2378	—	—	—
1450	2240	2349	2410	2081	2313	2379	—	—	—
1460	2197	2348	2411	—	—	—	—	—	—
1470	2109	2345	2412	—	—	—	—	—	—

Range of Dimensions:

Fin size: ± 1/32 in tolerance
 Fin thickness: 0.014 in to 0.031 aluminum
 Fin spacing: 30 to 52 fins per foot
 Center-to-center tier spacing (F) 6 in to 6-3/8 in

TABLE E8. Condensation Capacity of 1-1/4 in Copper 4-1/4 in Aluminum Units – Bare (Unpainted), Three Tiers									
One Tier	THREE TIERS (F = 6 in)								
	E = 3-3/4 (H=20)			E = 5-3/4 (H=22)			E = 7-3/4 (H=24)		
	D = 4-1/2	D = 4-3/4	D = 5	D = 4-1/2	D = 4-3/4	D = 5	D = 4-1/2	D = 4-3/4	D = 5
1150	2818	2883	2939	2795	2860	2918	2760	2828	2887
1160	2830	2897	2953	2808	2874	2932	2772	2842	2900
1170	2843	2910	2968	2820	2888	2948	2785	2855	2914
1180	2856	2924	2983	2832	2902	2962	2797	2868	2928
1190	2868	2937	2998	2844	2916	2975	2808	2880	2942
1200	2880	2951	3012	2856	2928	2989	2819	2892	2955
1210	2892	2964	3025	2868	2940	3002	2829	2904	2968
1220	2904	2977	3039	2879	2952	3015	2839	2916	2981
1230	2915	2989	3052	2889	2964	3028	2849	2927	2994
1240	2925	3001	3065	2899	2976	3041	2858	2939	3006
1250	2936	3013	3078	2909	2988	3054	2868	2950	3018
1260	2946	3024	3091	2918	2999	3067	2876	2960	3029
1270	2955	3035	3103	2927	3010	3078	2884	2969	3040
1280	2964	3046	3115	2936	3021	3090	2892	2978	3050
1290	2973	3057	3127	2945	3030	3101	2898	2986	3060
1300	2982	3067	3138	2952	3039	3111	2903	2994	3070
1310	2991	3077	3149	2959	3048	3121	2903	3001	3080
1320	2998	3086	3160	2965	3056	3131	2903	3008	3089
1330	3004	3095	3169	2970	3063	3141	2902	3015	3098
1340	3010	3102	3178	2969	3070	3150	2897	3020	3106
1350	3015	3109	3188	2969	3077	3159	2892	3025	3112
1360	3012	3116	3197	2968	3083	3168	2883	3031	3118
1370	3013	3122	3206	2962	3088	3176	2872	3032	3125
1380	3011	3128	3215	2955	3093	3182	2843	3035	3131
1390	3005	3133	3222	2947	3097	3187	2808	3037	3136
1400	2999	3137	3228	2934	3099	3193	2758	3038	3141
1410	2989	3141	3233	2905	3101	3199	2679	3037	3146
1420	2976	3143	3239	2868	3102	3204	2499	3036	3150
1430	2946	3145	3245	2817	3103	3209	—	—	—
1440	2909	3146	3249	2736	3102	3213	—	—	—
1450	2857	3147	3253	2552	3100	3216	—	—	—
1460	2774	3145	3257	—	—	—	—	—	—
1470	2587	3143	3260	—	—	—	—	—	—

Range of Dimensions:

Fin size: ± 1/32 in tolerance
 Fin thickness: 0.014 in to 0.031 aluminum
 Fin spacing: 30 to 52 fins per foot
 Center-to-center tier spacing (F) 6 in to 6-3/8 in

TABLE E9. Condensation Capacity of 1-1/4 in Copper 4-1/4 in Aluminum Units – Bare (Painted), Two Tiers									
One Tier	TWO TIERS (F = 6 in)								
	E = 3-3/4 (H=14)			E = 5-3/4 (H=16)			E = 7-3/4 (H=18)		
	D = 4-1/2	D = 4-3/4	D = 5	D = 4-1/2	D = 4-3/4	D = 5	D = 4-1/2	D = 4-3/4	D = 5
1240	2217	2249	2283	2207	2239	2273	2191	2223	2258
1250	2230	2263	2296	2219	2252	2286	2204	2236	2271
1260	2243	2276	2310	2231	2265	2300	2216	2249	2284
1270	2255	2289	2323	2244	2277	2313	2228	2261	2297
1280	2267	2301	2336	2257	2290	2326	2238	2272	2310
1290	2279	2313	2349	2269	2303	2339	2248	2283	2322
1300	2291	2325	2362	2280	2314	2351	2259	2294	2333
1310	2303	2338	2375	2290	2325	2364	2270	2306	2345
1320	2315	2350	2388	2301	2336	2376	2280	2317	2356
1330	2325	2361	2401	2311	2347	2387	2290	2327	2367
1340	2336	2372	2412	2322	2358	2399	2298	2337	2378
1350	2346	2383	2423	2333	2369	2410	2306	2346	2389
1360	2356	2394	2434	2342	2380	2421	2314	2355	2399
1370	2366	2404	2445	2350	2389	2432	2322	2362	2408
1380	2376	2414	2456	2358	2398	2443	2327	2368	2417
1390	2384	2424	2467	2366	2407	2452	2331	2375	2425
1400	2392	2433	2477	2373	2414	2461	2337	2382	2433
1410	2400	2442	2487	2377	2421	2470	2341	2389	2441
1420	2407	2448	2496	2381	2428	2478	2344	2395	2448
1430	2412	2454	2505	2387	2434	2485	2347	2401	2454
1440	2416	2461	2513	2390	2440	2492	2347	2405	2461
1450	2420	2468	2520	2393	2446	2498	2347	2407	2466
1460	2424	2475	2527	2396	2451	2505	2345	2409	2470
1470	2427	2480	2533	2396	2455	2512	2337	2412	2472
1480	2429	2485	2540	2396	2457	2516	2324	2414	2474
1490	2429	2488	2545	2393	2458	2521	2302	2414	2476
1500	2428	2490	2550	2385	2461	2523	2257	2412	2476
1510	2425	2492	2554	2371	2463	2525	2167	2408	2478
1520	2417	2494	2557	2348	2462	2526	—	—	—
1530	2402	2495	2558	2303	2460	2526	—	—	—
1540	2379	2495	2559	2210	2456	2527	—	—	—
1550	2333	2492	2559	—	—	—	—	—	—
1560	2239	2488	2560	—	—	—	—	—	—

Range of Dimensions:

- Fin size: ± 1/32 in tolerance
- Fin thickness: 0.014 in to 0.031 aluminum
- Fin spacing: 30 to 52 fins per foot
- Center-to-center tier spacing (F) 6 in to 6-3/8 in

TABLE E10. Condensation Capacity of 1-1/4 in Copper 4-1/4 in Aluminum Units - Bare (Painted), Three Tiers									
One Tier	THREE TIERS (F = 6 in)								
	E = 3-3/4 (H=20)			E = 5-3/4 (H=22)			E = 7-3/4 (H=24)		
	D = 4-1/2	D = 4-3/4	D = 5	D = 4-1/2	D = 4-3/4	D = 5	D = 4-1/2	D = 4-3/4	D = 5
1240	3038	3109	3169	3013	3084	3146	2976	3049	3112
1250	3050	3121	3182	3025	3097	3160	2988	3062	3125
1260	3062	3134	3196	3037	3110	3174	2999	3074	3138
1270	3073	3147	3210	3048	3123	3188	3010	3086	3151
1280	3085	3159	3224	3059	3136	3201	3020	3098	3164
1290	3096	3172	3238	3070	3148	3213	3030	3109	3177
1300	3107	3184	3251	3081	3159	3225	3039	3120	3189
1310	3118	3196	3263	3090	3170	3238	3048	3131	3201
1320	3128	3208	3275	3100	3181	3250	3057	3142	3213
1330	3138	3219	3287	3109	3192	3262	3066	3152	3224
1340	3148	3229	3299	3118	3203	3274	3074	3162	3235
1350	3156	3240	3311	3127	3213	3286	3082	3171	3245
1360	3165	3250	3322	3135	3223	3297	3089	3181	3255
1370	3173	3261	3334	3143	3233	3307	3094	3188	3265
1380	3181	3271	3345	3150	3242	3317	3099	3195	3274
1390	3189	3280	3355	3157	3250	3327	3104	3201	3283
1400	3196	3289	3365	3163	3258	3336	3101	3207	3291
1410	3202	3296	3375	3167	3264	3344	3100	3213	3299
1420	3208	3303	3383	3171	3270	3353	3098	3219	3307
1430	3212	3310	3392	3169	3276	3362	3092	3223	3315
1440	3215	3316	3401	3166	3282	3370	3084	3227	3320
1450	3212	3322	3409	3162	3287	3378	3074	3231	3325
1460	3210	3327	3416	3156	3291	3384	3060	3231	3330
1470	3207	3332	3425	3149	3294	3389	3028	3232	3335
1480	3200	3336	3431	3138	3297	3394	2990	3232	3339
1490	3191	3339	3436	3123	3297	3399	2935	3233	3343
1500	3180	3342	3440	3099	3298	3403	2850	3231	3346
1510	3165	3342	3444	3050	3298	3407	2658	3228	3349
1520	3131	3342	3448	2994	3298	3411	—	—	—
1530	3091	3342	3452	2901	3296	3413	—	—	—
1540	3034	3342	3456	2710	3292	3416	—	—	—
1550	2945	3339	3458	—	—	—	—	—	—
1560	2746	3335	3460	—	—	—	—	—	—

Range of Dimensions:

Fin size: ± 1/32 in tolerance
 Fin thickness: 0.014 in to 0.031 aluminum
 Fin spacing: 30 to 52 fins per foot
 Center-to-center tier spacing (F) 6 in to 6-3/8 in

TABLE E11. Condensation Capacity of 1-1/4 in Copper 3-1/4 in Aluminum Units – Bare (Unpainted), Two Tiers									
One Tier	TWO TIERS (F = 6 in)								
	E = 4-3/4 (H=14)			E = 6-3/4 (H=16)			E = 8-3/4 (H=18)		
	D = 3-1/2	D = 3-3/4	D = 4	D = 3-1/2	D = 3-3/4	D = 4	D = 3-1/2	D = 3-3/4	D = 4
830	1492	1512	1535	1487	1508	1532	1477	1499	1522
840	1505	1526	1550	1500	1522	1546	1489	1511	1536
850	1518	1539	1564	1513	1535	1559	1501	1523	1549
860	1531	1553	1577	1525	1548	1572	1512	1534	1561
870	1543	1565	1590	1536	1559	1585	1523	1546	1572
880	1554	1577	1603	1547	1570	1597	1534	1558	1584
890	1565	1589	1615	1558	1582	1608	1545	1569	1596
900	1576	1601	1626	1569	1593	1620	1555	1580	1607
910	1586	1612	1638	1580	1604	1632	1564	1591	1617
920	1597	1622	1650	1590	1615	1643	1572	1600	1627
930	1607	1632	1661	1598	1625	1653	1580	1608	1637
940	1616	1642	1672	1606	1635	1663	1586	1615	1646
950	1624	1652	1681	1614	1642	1672	1591	1622	1654
960	1630	1659	1690	1620	1649	1681	1596	1628	1661
970	1636	1666	1698	1625	1656	1689	1600	1634	1668
980	1642	1673	1706	1630	1662	1696	1599	1639	1675
990	1646	1679	1714	1633	1667	1703	1594	1641	1679
1000	1649	1684	1720	1632	1672	1709	1585	1640	1682
1010	1648	1689	1726	1626	1675	1714	1567	1639	1681
1020	1642	1691	1728	1617	1672	1716	—	—	—
1030	1633	1688	1732	1596	1661	1714	—	—	—
1040	1613	1688	1731	—	—	—	—	—	—

Range of Dimensions:

- Fin size: $\pm 1/32$ in tolerance
- Fin thickness: 0.014 in to 0.031 aluminum
- Fin spacing: 30 to 52 fins per foot
- Center-to-center tier spacing (F) 6 in to 6-3/8 in

TABLE E12. Condensation Capacity of 1-1/4 in Copper 3-1/4 in Aluminum Units - Bare (Unpainted), Three Tiers									
One Tier	THREE TIERS (F = 6 in)								
	E = 4-3/4 (H=20)			E = 6-3/4 (H=22)			E = 8-3/4 (H=24)		
	D = 3-1/2	D = 3-3/4	D = 4	D = 3-1/2	D = 3-3/4	D = 4	D = 3-1/2	D = 3-3/4	D = 4
830	2053	2101	2136	2042	2087	2127	2017	2063	2107
840	2066	2113	2153	2054	2100	2142	2029	2076	2124
850	2078	2125	2168	2066	2113	2157	2041	2089	2140
860	2090	2138	2183	2078	2126	2169	2052	2100	2144
870	2101	2150	2195	2089	2138	2181	2062	2111	2156
880	2111	2163	2207	2099	2149	2194	2071	2122	2167
890	2121	2173	2219	2109	2160	2206	2078	2132	2179
900	2131	2184	2230	2118	2170	2217	2086	2142	2191
910	2140	2194	2241	2126	2180	2228	2094	2152	2202
920	2149	2204	2252	2135	2190	2240	2100	2161	2213
930	2156	2213	2264	2143	2199	2251	2105	2169	2222
940	2163	2223	2275	2149	2208	2261	2109	2176	2230
950	2168	2232	2285	2150	2215	2269	2112	2182	2238
960	2172	2239	2293	2154	2222	2277	2110	2188	2246
970	2176	2246	2301	2156	2228	2285	2109	2192	2253
980	2179	2251	2309	2154	2233	2293	2097	2194	2259
990	2176	2256	2317	2150	2237	2299	2084	2196	2262
1000	2175	2260	2323	2140	2239	2305	2060	2197	2264
1010	2161	2261	2328	2126	2240	2308	1993	2196	2265
1020	2147	2262	2331	2101	2241	2309	—	—	—
1030	2122	2263	2332	2032	2239	2310	—	—	—
1040	2052	2261	2333	—	—	—	—	—	—

Range of Dimensions:

Fin size: ± 1/32 in tolerance
 Fin thickness: 0.014 in to 0.031 aluminum
 Fin spacing: 30 to 52 fins per foot
 Center-to-center tier spacing (F) 6 in to 6-3/8 in

TABLE E13. Condensation Capacity of 1-1/4 in Copper 3-1/4 in Aluminum Units – Bare (Painted), Two Tiers									
One Tier	TWO TIERS (F = 6 in)								
	E = 4-3/4 (H=14)			E = 6-3/4 (H=16)			E = 8-3/4 (H=18)		
	D = 3-1/2	D = 3-3/4	D = 4	D = 3-1/2	D = 3-3/4	D = 4	D = 3-1/2	D = 3-3/4	D = 4
900	1617	1639	1665	1612	1635	1660	1602	1625	1651
910	1631	1653	1678	1625	1647	1674	1613	1637	1663
920	1643	1667	1692	1638	1660	1687	1624	1648	1675
930	1655	1680	1706	1649	1672	1700	1635	1659	1687
940	1667	1691	1718	1660	1684	1713	1646	1671	1698
950	1678	1702	1731	1670	1696	1724	1656	1682	1710
960	1688	1714	1742	1681	1708	1735	1666	1692	1721
970	1698	1726	1753	1691	1718	1746	1676	1703	1732
980	1708	1736	1764	1701	1728	1757	1685	1713	1742
990	1718	1745	1775	1711	1738	1768	1692	1722	1751
1000	1728	1755	1786	1719	1748	1779	1699	1729	1760
1010	1736	1765	1795	1726	1756	1787	1704	1735	1768
1020	1743	1774	1804	1732	1764	1795	1709	1741	1776
1030	1750	1781	1813	1738	1770	1804	1712	1747	1783
1040	1754	1788	1822	1742	1776	1811	1715	1752	1789
1050	1759	1794	1828	1746	1781	1818	1714	1756	1795
1060	1763	1798	1835	1748	1785	1824	1707	1757	1796
1070	1764	1802	1841	1746	1789	1829	1696	1754	1800
1080	1763	1806	1847	1739	1791	1830	1675	1750	1798
1090	1755	1807	1847	1728	1787	1830	—	—	—
1100	1744	1805	1847	1706	1785	1829	—	—	—
1110	1722	1802	1845	—	—	—	—	—	—

Range of Dimensions:

- Fin size: ± 1/32 in tolerance
- Fin thickness: 0.014 in to 0.031 aluminum
- Fin spacing: 30 to 52 fins per foot
- Center-to-center tier spacing (F) 6 in to 6-3/8 in

TABLE E14. Condensation Capacity of 1-1/4 in Copper 3-1/4 in Aluminum Units – Bare (Painted), Three Tiers									
One Tier	THREE TIERS (F = 6 in)								
	E = 4-3/4 (H=20)			E = 6-3/4 (H=22)			E = 8-3/4 (H=24)		
	D = 3-1/2	D = 3-3/4	D = 4	D = 3-1/2	D = 3-3/4	D = 4	D = 3-1/2	D = 3-3/4	D = 4
900	2226	2279	2317	2214	2263	2307	2189	2237	2284
910	2238	2289	2332	2225	2275	2321	2199	2249	2296
920	2249	2300	2345	2236	2286	2335	2209	2261	2307
930	2260	2311	2358	2247	2297	2346	2219	2271	2319
940	2270	2322	2370	2257	2309	2357	2228	2281	2330
950	2280	2333	2382	2267	2320	2368	2236	2291	2340
960	2289	2344	2393	2275	2330	2379	2243	2300	2350
970	2298	2354	2404	2282	2340	2389	2249	2309	2361
980	2306	2364	2414	2289	2348	2399	2255	2318	2371
990	2313	2372	2424	2295	2356	2410	2260	2326	2381
1000	2318	2380	2434	2301	2365	2420	2263	2332	2389
1010	2324	2388	2444	2305	2372	2429	2266	2338	2396
1020	2328	2395	2453	2308	2379	2436	2267	2343	2403
1030	2331	2401	2461	2311	2384	2443	2264	2347	2410
1040	2334	2408	2467	2314	2389	2450	2260	2350	2415
1050	2334	2413	2473	2317	2393	2457	2247	2351	2420
1060	2330	2416	2480	2316	2396	2461	2231	2351	2422
1070	2328	2418	2484	2300	2396	2465	2204	2351	2422
1080	2311	2418	2489	2273	2395	2468	2130	2348	2422
1090	2294	2418	2491	2235	2395	2468	—	—	—
1100	2266	2417	2490	2170	2391	2467	—	—	—
1110	2190	2413	2490	—	—	—	—	—	—

Range of Dimensions:

- Fin size: $\pm 1/32$ in tolerance
- Fin thickness: 0.014 in to 0.031 aluminum
- Fin spacing: 30 to 52 fins per foot
- Center-to-center tier spacing (F) 6 in to 6-3/8 in

APPENDIX F – TABLES FOR DETERMINING AHRI WATER RATINGS AT AVERAGE WATER TEMPERATURE BASED ON THE AHRI STEAM RATING - INFORMATIVE

The AHRI water rating at average water temperatures shall be determined from the AHRI steam rating based on the tables in Appendix F

TO USE THIS TABLE: Enter the left-hand column at the AHRI steam rating. Proceed to the right to the column headed by the correct average water temperature and read the water rating.

AHRI Steam Rating, Btu/h-ft	TABLE F. AHRI Water Ratings at Average Water Temperature, Btu/h-ft																		
	150	155	160	165	170	175	180	185	190	195	200	205	210	215	220	225	230	235	240
600	270	290	320	340	370	390	410	440	470	490	520	550	570	600	630	650	680	720	750
610	270	300	320	350	370	400	420	450	480	500	520	560	580	610	640	660	700	730	760
620	280	300	330	350	380	400	430	450	480	510	530	560	590	620	650	680	710	740	780
630	280	310	330	360	380	410	430	460	490	520	540	570	600	630	660	690	720	760	790
640	290	310	340	360	390	420	440	470	500	520	550	580	610	640	670	700	730	770	800
650	290	320	340	370	400	420	450	470	510	530	560	590	620	650	680	710	740	780	810
660	300	320	350	380	400	430	460	480	510	540	570	600	630	660	690	720	750	790	830
670	300	330	360	380	410	440	460	490	520	550	580	610	640	670	700	730	760	800	840
680	310	330	360	390	410	440	470	500	530	560	580	620	650	680	710	740	780	820	850
690	310	340	370	390	420	450	480	500	540	570	590	630	660	690	720	750	790	830	860
700	320	340	370	400	430	460	480	510	550	570	600	640	670	700	740	760	800	840	880
710	320	350	380	400	430	460	490	520	550	580	610	650	670	710	750	770	810	850	890
720	320	350	380	410	440	470	500	530	560	590	620	660	680	720	760	780	820	860	900
730	330	360	390	420	450	470	500	530	570	600	630	660	690	730	770	800	830	880	910
740	330	360	390	420	450	480	510	540	580	610	640	670	700	740	780	810	840	890	930
750	340	370	400	430	460	490	520	550	590	620	650	680	710	750	790	820	860	900	940
760	340	370	400	430	460	490	520	550	590	620	650	690	720	760	800	830	870	910	950
770	350	380	410	440	470	500	530	560	600	630	660	700	730	770	810	840	880	920	960
780	350	380	410	440	480	510	540	570	610	640	670	710	740	780	820	850	890	940	980
790	360	390	420	450	480	510	550	580	620	650	680	720	750	790	830	860	900	950	990
800	360	390	420	460	490	520	550	580	620	660	690	730	760	800	840	870	910	960	1000
810	360	400	430	460	490	530	560	590	630	660	700	740	770	810	850	880	920	970	1010
820	370	400	430	470	500	530	570	600	640	670	710	750	780	820	860	890	930	980	1030
830	370	410	440	470	510	540	570	610	650	680	710	760	790	830	870	900	950	1000	1040
840	380	410	450	480	510	550	580	610	660	690	720	760	800	840	880	920	960	1010	1050
850	380	420	450	480	520	550	590	620	660	700	730	770	810	850	890	930	970	1020	1060
860	390	420	460	490	520	560	590	630	670	710	740	780	820	860	900	940	980	1030	1080
870	390	430	460	500	530	570	600	640	680	710	750	790	830	870	910	950	990	1040	1090
880	400	430	470	500	540	570	610	640	690	720	760	800	840	880	920	960	1000	1060	1100
890	400	440	470	510	540	580	610	650	690	730	770	810	850	890	930	970	1010	1070	1110
900	410	440	480	510	550	590	620	660	700	740	770	820	860	900	950	980	1030	1080	1130
910	410	450	480	520	560	590	630	660	710	750	780	830	860	910	960	990	1040	1090	1140
920	410	450	490	520	560	600	630	670	720	750	790	840	870	920	970	1000	1050	1100	1150
930	420	460	490	530	570	600	640	680	730	760	800	850	880	930	980	1010	1060	1120	1160
940	420	460	500	540	570	610	650	690	730	770	810	860	890	940	990	1020	1070	1130	1180
950	430	470	500	540	580	620	660	690	740	780	820	860	900	950	1000	1040	1080	1140	1190
960	430	470	510	550	590	620	660	700	750	790	830	870	910	960	1010	1050	1090	1150	1200
970	440	480	510	550	590	630	670	710	760	800	830	880	920	970	1020	1060	1110	1160	1210
980	440	480	520	560	600	640	680	720	760	800	840	890	930	980	1030	1070	1120	1180	1230
990	450	490	520	560	600	640	680	720	770	810	850	900	940	990	1040	1080	1130	1190	1240
1000	450	490	530	570	610	650	690	730	780	820	860	910	950	1000	1050	1090	1140	1200	1250
1010	450	490	540	580	620	660	700	740	790	830	870	920	960	1010	1060	1100	1150	1210	1260
1020	460	500	540	580	620	660	700	740	800	840	880	930	970	1020	1070	1110	1160	1220	1280
1030	460	500	550	590	630	670	710	750	800	840	890	940	980	1030	1080	1120	1170	1240	1290
1040	470	510	550	590	630	680	720	760	810	850	890	950	990	1040	1090	1130	1190	1250	1300
1050	470	510	560	600	640	680	720	770	820	860	900	960	1000	1050	1100	1140	1200	1260	1310
1060	480	520	560	600	650	690	730	770	830	870	910	960	1010	1060	1110	1160	1210	1270	1330
1070	480	520	570	610	650	700	740	780	830	880	920	970	1020	1070	1120	1170	1220	1280	1340
1080	490	530	570	620	660	700	750	790	840	890	930	980	1030	1080	1130	1180	1230	1300	1350
1090	490	530	580	620	660	710	750	800	850	890	940	990	1040	1090	1140	1190	1240	1310	1360
1100	500	540	580	630	670	720	760	800	860	900	950	1000	1050	1100	1160	1200	1250	1320	1380
1110	500	540	590	630	680	720	770	810	870	910	950	1010	1050	1110	1170	1210	1270	1330	1390
1120	500	550	590	640	680	730	770	820	870	920	960	1020	1060	1120	1180	1220	1280	1340	1400
1130	510	550	600	640	690	730	780	820	880	930	970	1030	1070	1130	1190	1230	1290	1360	1410
1140	510	560	600	650	700	740	790	830	890	930	980	1040	1080	1140	1200	1240	1300	1370	1430
1150	520	560	610	660	700	750	790	840	900	940	990	1050	1090	1150	1210	1250	1310	1380	1440
1160	520	570	610	660	710	750	800	850	900	950	1000	1060	1100	1160	1220	1260	1320	1390	1450
1170	530	570	620	670	710	760	810	850	910	960	1010	1060	1110	1170	1230	1280	1330	1400	1460
1180	530	580	630	670	720	770	810	860	920	970	1010	1070	1120	1180	1240	1290	1350	1420	1480
1190	540	580	630	680	730	770	820	870	930	980	1020	1080	1130	1190	1250	1300	1360	1430	1490
	150	155	160	165	170	175	180	185	190	195	200	205	210	215	220	225	230	235	240

AHRI STANDARD 1410-2017 (R2024) (I-P)

AHRI Steam Rating, Btu/h-ft	TABLE F (cont.). AHRI Water Ratings at Average Water Temperature, Btu/h-ft																		
	150	155	160	165	170	175	180	185	190	195	200	205	210	215	220	225	230	235	240
1200	540	590	640	680	730	780	830	880	940	980	1030	1090	1140	1200	1260	1310	1370	1440	1500
1210	540	590	640	690	740	790	830	880	940	990	1040	1100	1150	1210	1270	1320	1380	1450	1510
1220	550	600	650	700	740	790	840	890	950	1000	1050	1110	1160	1220	1280	1330	1390	1460	1530
1230	550	600	650	700	750	800	850	900	960	1010	1060	1120	1170	1230	1290	1340	1400	1480	1540
1240	560	610	660	710	760	810	860	910	970	1020	1070	1130	1180	1240	1300	1350	1410	1490	1550
1250	560	610	660	710	760	810	860	910	980	1030	1080	1140	1190	1250	1310	1360	1430	1500	1560
1260	570	620	670	720	770	820	870	920	980	1030	1080	1150	1200	1260	1320	1370	1440	1510	1580
1270	570	620	670	720	770	830	880	930	990	1040	1090	1160	1210	1270	1330	1380	1450	1520	1590
1280	580	630	680	730	780	830	880	930	1000	1050	1100	1160	1220	1280	1340	1400	1460	1540	1600
1290	580	630	680	740	790	840	890	940	1010	1060	1110	1170	1230	1290	1350	1410	1470	1550	1610
1300	590	640	690	740	790	850	900	950	1010	1070	1120	1180	1240	1300	1370	1420	1480	1560	1630
1310	590	640	690	750	800	850	900	960	1020	1070	1130	1190	1240	1310	1380	1430	1490	1570	1640
1320	590	650	700	750	810	860	910	960	1030	1080	1140	1200	1250	1320	1390	1440	1500	1580	1650
1330	600	650	700	760	810	860	920	970	1040	1090	1140	1210	1260	1330	1400	1450	1520	1600	1660
1340	600	660	710	760	820	870	920	980	1050	1100	1150	1220	1270	1340	1410	1460	1530	1610	1680
1350	610	660	720	770	820	880	930	990	1050	1110	1160	1230	1280	1350	1420	1470	1540	1620	1690
1360	610	670	720	780	830	880	940	990	1060	1120	1170	1240	1290	1360	1430	1480	1550	1630	1700
1370	620	670	730	780	840	890	950	1000	1070	1120	1180	1250	1300	1370	1440	1490	1560	1640	1710
1380	620	680	730	790	840	900	950	1010	1080	1130	1190	1260	1310	1380	1450	1500	1570	1660	1730
1390	630	680	740	790	850	900	960	1010	1080	1140	1200	1260	1320	1390	1460	1520	1580	1670	1740
1400	630	690	740	800	850	910	970	1020	1090	1150	1200	1270	1330	1400	1470	1530	1600	1680	1750
1410	630	690	750	800	860	920	970	1030	1100	1160	1210	1280	1340	1410	1480	1540	1610	1690	1760
1420	640	700	750	810	870	920	980	1040	1110	1160	1220	1290	1350	1420	1490	1550	1620	1700	1780
1430	640	700	760	820	870	930	990	1040	1120	1170	1230	1300	1360	1430	1500	1560	1630	1720	1790
1440	650	710	760	820	880	940	990	1050	1120	1180	1240	1310	1370	1440	1510	1570	1640	1730	1800
1450	650	710	770	830	880	940	1000	1060	1130	1190	1250	1320	1380	1450	1520	1580	1650	1740	1810
1460	660	720	770	830	890	950	1010	1070	1140	1200	1260	1330	1390	1460	1530	1590	1660	1750	1830
1470	660	720	780	840	900	960	1010	1070	1150	1210	1260	1340	1400	1470	1540	1600	1680	1760	1840
1480	670	730	780	840	900	960	1020	1080	1150	1210	1270	1350	1410	1480	1550	1610	1690	1780	1850
1490	670	730	790	850	910	970	1030	1090	1160	1220	1280	1360	1420	1490	1560	1620	1700	1790	1860
1500	680	740	800	860	920	980	1040	1100	1170	1230	1290	1370	1430	1500	1580	1640	1710	1800	1880
1510	680	740	800	860	920	980	1040	1100	1180	1240	1300	1370	1430	1510	1590	1650	1720	1810	1890
1520	680	740	810	870	930	990	1050	1110	1190	1250	1310	1380	1440	1520	1600	1660	1730	1820	1900
1530	690	750	810	870	930	990	1060	1120	1190	1250	1320	1390	1450	1530	1610	1670	1740	1840	1910
1540	690	760	820	880	940	1000	1060	1120	1200	1260	1320	1400	1460	1540	1620	1680	1760	1850	1930
1550	700	760	820	880	950	1010	1070	1130	1210	1270	1330	1410	1470	1550	1630	1690	1770	1860	1940
1560	700	760	830	890	950	1010	1080	1140	1220	1280	1340	1420	1480	1560	1640	1700	1780	1870	1950
1570	710	770	830	890	960	1020	1080	1150	1220	1290	1350	1430	1490	1570	1650	1710	1790	1880	1960
1580	710	770	840	900	960	1030	1090	1150	1230	1300	1360	1440	1500	1580	1660	1720	1800	1900	1980
1590	720	780	840	910	970	1030	1100	1160	1240	1300	1370	1450	1510	1590	1670	1730	1810	1910	1990
1600	720	780	850	910	980	1040	1100	1170	1250	1310	1380	1460	1520	1600	1680	1740	1820	1920	2000
1610	720	790	850	920	980	1050	1110	1180	1260	1320	1380	1470	1530	1610	1690	1750	1840	1930	2010
1620	730	790	860	920	990	1050	1120	1180	1260	1330	1390	1470	1540	1620	1700	1770	1850	1940	2030
1630	730	800	860	930	990	1060	1120	1190	1270	1340	1400	1480	1550	1630	1710	1780	1860	1960	2040
1640	740	800	870	930	1000	1070	1130	1200	1280	1340	1410	1490	1560	1640	1720	1790	1870	1970	2050
1650	740	810	870	940	1010	1070	1140	1200	1290	1350	1420	1500	1570	1650	1730	1800	1880	1980	2060
1660	750	810	880	950	1010	1080	1150	1210	1290	1360	1430	1510	1580	1660	1740	1810	1890	1990	2080
1670	750	820	890	950	1020	1090	1150	1220	1300	1370	1440	1520	1590	1670	1750	1820	1900	2000	2090
1680	760	820	890	960	1020	1090	1160	1230	1310	1380	1440	1530	1600	1680	1760	1830	1920	2020	2100
1690	760	830	900	960	1030	1100	1170	1230	1320	1390	1450	1540	1610	1690	1770	1840	1930	2030	2110
1700	770	830	900	970	1040	1110	1170	1240	1330	1390	1460	1550	1620	1700	1790	1850	1940	2040	2130
1710	770	840	910	970	1040	1110	1180	1250	1330	1400	1470	1560	1620	1710	1800	1860	1950	2050	2140
1720	770	840	910	980	1050	1120	1190	1260	1340	1410	1480	1570	1630	1720	1810	1870	1960	2060	2150
1730	780	850	920	990	1060	1130	1190	1260	1350	1420	1490	1570	1640	1730	1820	1890	1970	2080	2160
1740	780	850	920	990	1060	1130	1200	1270	1360	1430	1500	1580	1650	1740	1830	1900	1980	2090	2180
1750	790	860	930	1000	1070	1140	1210	1280	1370	1440	1510	1590	1660	1750	1840	1910	2000	2100	2190
1760	790	860	930	1000	1070	1140	1210	1280	1370	1440	1510	1600	1670	1760	1850	1920	2010	2110	2200
1770	800	870	940	1010	1080	1150	1220	1290	1380	1450	1520	1610	1680	1770	1860	1930	2020	2120	2210
1780	800	870	940	1010	1090	1160	1230	1300	1390	1460	1530	1620	1690	1780	1870	1940	2030	2140	2230
1790	810	880	950	1020	1090	1160	1240	1310	1400	1470	1540	1630	1700	1790	1880	1950	2040	2150	2240
	150	155	160	165	170	175	180	185	190	195	200	205	210	215	220	225	230	235	240

AHRI Steam Rating, Btu/h-ft	TABLE F (cont.). AHRI Water Ratings at Average Water Temperature, Btu/h-ft																		
	150	155	160	165	170	175	180	185	190	195	200	205	210	215	220	225	230	235	240
1800	810	880	950	1030	1100	1170	1240	1310	1400	1480	1550	1640	1710	1800	1890	1960	2050	2160	2250
1810	810	890	960	1030	1100	1180	1250	1320	1410	1480	1560	1650	1720	1810	1900	1970	2060	2170	2260
1820	820	890	960	1040	1110	1180	1260	1330	1420	1490	1570	1660	1730	1820	1910	1980	2070	2180	2280
1830	820	900	970	1040	1120	1190	1260	1340	1430	1500	1570	1670	1740	1830	1920	1990	2090	2200	2290
1840	830	900	980	1050	1120	1200	1270	1340	1440	1510	1580	1670	1750	1840	1930	2010	2100	2210	2300
1850	830	910	980	1050	1130	1200	1280	1350	1440	1520	1590	1680	1760	1850	1940	2020	2110	2220	2310
1860	840	910	990	1060	1130	1210	1280	1360	1450	1530	1600	1690	1770	1860	1950	2030	2120	2230	2330
1870	840	920	990	1070	1140	1220	1290	1370	1460	1530	1610	1700	1780	1870	1960	2040	2130	2240	2340
1880	850	920	1000	1070	1150	1220	1300	1370	1470	1540	1620	1710	1790	1880	1970	2050	2140	2260	2350
1890	850	930	1000	1080	1150	1230	1300	1380	1470	1550	1630	1720	1800	1890	1980	2060	2150	2270	2360
1900	860	930	1010	1080	1160	1240	1310	1390	1480	1560	1630	1730	1810	1900	2000	2070	2170	2280	2380
1910	860	940	1010	1090	1170	1240	1320	1390	1490	1570	1640	1740	1810	1910	2010	2080	2180	2290	2390
1920	860	940	1020	1090	1170	1250	1320	1400	1500	1570	1650	1750	1820	1920	2020	2090	2190	2300	2400
1930	870	950	1020	1100	1180	1250	1330	1410	1510	1580	1660	1760	1830	1930	2030	2100	2200	2320	2410
1940	870	950	1030	1110	1180	1260	1340	1420	1510	1590	1670	1770	1840	1940	2040	2110	2210	2330	2430
1950	880	960	1030	1110	1190	1270	1350	1420	1520	1600	1680	1770	1850	1950	2050	2130	2220	2340	2440
1960	880	960	1040	1120	1200	1270	1350	1430	1530	1610	1690	1780	1860	1960	2060	2140	2230	2350	2450
1970	890	970	1040	1120	1200	1280	1360	1440	1540	1620	1690	1790	1870	1970	2070	2150	2250	2360	2460
1980	890	970	1050	1130	1210	1290	1370	1450	1540	1620	1700	1800	1880	1980	2080	2160	2260	2380	2480
1990	900	980	1050	1130	1210	1290	1370	1450	1550	1630	1710	1810	1890	1990	2090	2170	2270	2390	2490
2000	900	980	1060	1140	1220	1300	1380	1460	1560	1640	1720	1820	1900	2000	2100	2180	2280	2400	2500
2010	900	980	1070	1150	1230	1310	1390	1470	1570	1650	1730	1830	1910	2010	2110	2190	2290	2410	2510
2020	910	990	1070	1150	1230	1310	1390	1470	1580	1660	1740	1840	1920	2020	2120	2200	2300	2420	2530
2030	910	990	1080	1160	1240	1320	1400	1480	1580	1660	1750	1850	1930	2030	2130	2210	2310	2440	2540
2040	920	1000	1080	1160	1240	1330	1410	1490	1590	1670	1750	1860	1940	2040	2140	2220	2330	2450	2550
2050	920	1000	1090	1170	1250	1330	1410	1500	1600	1680	1760	1870	1950	2050	2150	2230	2340	2460	2560
2060	930	1010	1090	1170	1260	1340	1420	1500	1610	1690	1770	1870	1960	2060	2160	2250	2350	2470	2580
2070	930	1010	1100	1180	1260	1350	1430	1510	1610	1700	1780	1880	1970	2070	2170	2260	2360	2480	2590
2080	940	1020	1100	1190	1270	1350	1440	1520	1620	1710	1790	1890	1980	2080	2180	2270	2370	2500	2600
2090	940	1020	1110	1190	1270	1360	1440	1530	1630	1710	1800	1900	1990	2090	2190	2280	2380	2510	2610
2100	950	1030	1110	1200	1280	1370	1450	1530	1640	1720	1810	1910	2000	2100	2210	2290	2390	2520	2630
2110	950	1030	1120	1200	1290	1370	1460	1540	1650	1730	1810	1920	2000	2110	2220	2300	2410	2530	2640
2120	950	1040	1120	1210	1290	1380	1460	1550	1650	1740	1820	1930	2010	2120	2230	2310	2420	2540	2650
2130	960	1040	1130	1210	1300	1380	1470	1550	1660	1750	1830	1940	2020	2130	2240	2320	2430	2560	2660
2140	960	1050	1130	1220	1310	1390	1480	1560	1670	1750	1840	1950	2030	2140	2250	2330	2440	2570	2680
2150	970	1050	1140	1230	1310	1400	1480	1570	1680	1760	1850	1960	2040	2150	2260	2340	2450	2580	2690
2160	970	1060	1140	1230	1320	1400	1490	1580	1680	1770	1860	1970	2050	2160	2270	2350	2460	2590	2700
2170	980	1060	1150	1240	1320	1410	1500	1580	1690	1780	1870	1970	2060	2170	2280	2370	2470	2600	2710
2180	980	1070	1160	1240	1330	1420	1500	1590	1700	1790	1870	1980	2070	2180	2290	2380	2490	2620	2730
2190	990	1070	1160	1250	1340	1420	1510	1600	1710	1800	1880	1990	2080	2190	2300	2390	2500	2630	2740
2200	990	1080	1170	1250	1340	1430	1520	1610	1720	1800	1890	2000	2090	2200	2310	2400	2510	2640	2750
2210	990	1080	1170	1260	1350	1440	1520	1610	1720	1810	1900	2010	2100	2210	2320	2410	2520	2650	2760
2220	1000	1090	1180	1270	1350	1440	1530	1620	1730	1820	1910	2020	2110	2220	2330	2420	2530	2660	2780
2230	1000	1090	1180	1270	1360	1450	1540	1630	1740	1830	1920	2030	2120	2230	2340	2430	2540	2680	2790
2240	1010	1100	1190	1280	1370	1460	1550	1640	1750	1840	1930	2040	2130	2240	2350	2440	2550	2690	2800
2250	1010	1100	1190	1280	1370	1460	1550	1640	1760	1850	1940	2050	2140	2250	2360	2450	2570	2700	2810
2260	1020	1110	1200	1290	1380	1470	1560	1650	1760	1850	1940	2060	2150	2260	2370	2460	2580	2710	2830
2270	1020	1110	1200	1290	1380	1480	1570	1660	1770	1860	1950	2070	2160	2270	2380	2470	2590	2720	2840
2280	1030	1120	1210	1300	1390	1480	1570	1660	1780	1870	1960	2070	2170	2280	2390	2490	2600	2740	2850
2290	1030	1120	1210	1310	1400	1490	1580	1670	1790	1880	1970	2080	2180	2290	2400	2500	2610	2750	2860
2300	1040	1130	1220	1310	1400	1500	1590	1680	1790	1890	1980	2090	2190	2300	2420	2510	2620	2760	2880
2310	1040	1130	1220	1320	1410	1500	1590	1690	1800	1890	1990	2100	2190	2310	2430	2520	2630	2770	2890
2320	1040	1140	1230	1320	1420	1510	1600	1690	1810	1900	2000	2110	2200	2320	2440	2530	2640	2780	2900
2330	1050	1140	1230	1330	1420	1510	1610	1700	1820	1910	2000	2120	2210	2330	2450	2540	2660	2800	2910
2340	1050	1150	1240	1330	1430	1520	1610	1710	1830	1920	2010	2130	2220	2340	2460	2550	2670	2810	2930
2350	1060	1150	1250	1340	1430	1530	1620	1720	1830	1930	2020	2140	2230	2350	2470	2560	2680	2820	2940
2360	1060	1160	1250	1350	1440	1530	1630	1720	1840	1940	2030	2150	2240	2360	2480	2570	2690	2830	2950
2370	1070	1160	1260	1350	1450	1540	1640	1730	1850	1940	2040	2160	2250	2370	2490	2580	2700	2840	2960
2380	1070	1170	1260	1360	1450	1550	1640	1740	1860	1950	2050	2170	2260	2380	2500	2590	2710	2860	2980
2390	1080	1170	1270	1360	1460	1550	1650	1740	1860	1960	2060	2170	2270	2390	2510	2610	2720	2870	2990
	150	155	160	165	170	175	180	185	190	195	200	205	210	215	220	225	230	235	240

AHRI STANDARD 1410-2017 (R2024) (I-P)

AHRI Steam Rating, Btu/h-ft	TABLE F (cont.). AHRI Water Ratings at Average Water Temperature, Btu/h-ft																		
	150	155	160	165	170	175	180	185	190	195	200	205	210	215	220	225	230	235	240
2400	1080	1180	1270	1370	1460	1560	1660	1750	1870	1970	2060	2180	2280	2400	2520	2620	2740	2880	3000
2410	1080	1180	1280	1370	1470	1570	1660	1760	1880	1980	2070	2190	2290	2410	2530	2630	2750	2890	3010
2420	1090	1190	1280	1380	1480	1570	1670	1770	1890	1980	2080	2200	2300	2420	2540	2640	2760	2900	3030
2430	1090	1190	1290	1390	1480	1580	1680	1770	1900	1990	2090	2210	2310	2430	2550	2650	2770	2920	3040
2440	1100	1200	1290	1390	1490	1590	1680	1780	1900	2000	2100	2220	2320	2440	2560	2660	2780	2930	3050
2450	1100	1200	1300	1400	1490	1590	1690	1790	1910	2010	2110	2230	2330	2450	2570	2670	2790	2940	3060
2460	1110	1210	1300	1400	1500	1600	1700	1800	1920	2020	2120	2240	2340	2460	2580	2680	2800	2950	3080
2470	1110	1210	1310	1410	1510	1610	1700	1800	1930	2030	2120	2250	2350	2470	2590	2690	2820	2960	3090
2480	1120	1220	1310	1410	1510	1610	1710	1810	1930	2030	2130	2260	2360	2480	2600	2700	2830	2980	3100
2490	1120	1220	1320	1420	1520	1620	1720	1820	1940	2040	2140	2270	2370	2490	2610	2710	2840	2990	3110
2500	1130	1230	1330	1430	1530	1630	1730	1830	1950	2050	2150	2280	2380	2500	2630	2730	2850	3000	3230
2510	1130	1230	1330	1430	1530	1630	1730	1830	1960	2060	2160	2290	2390	2510	2640	2740	2860	3010	3140
2520	1130	1230	1340	1440	1540	1640	1740	1840	1970	2070	2170	2290	2390	2520	2650	2750	2870	3020	3150
2530	1140	1240	1340	1440	1540	1640	1750	1850	1970	2070	2180	2300	2400	2530	2660	2760	2880	3040	3160
2540	1140	1240	1350	1450	1550	1650	1750	1850	1980	2080	2180	2310	2410	2540	2670	2770	2900	3050	3180
2550	1150	1250	1350	1450	1560	1660	1760	1860	1990	2090	2190	2320	2420	2550	2680	2780	2910	3060	3190
2560	1150	1250	1360	1460	1560	1660	1770	1870	2000	2100	2200	2330	2430	2560	2690	2790	2920	3070	3200
2570	1160	1260	1360	1460	1570	1670	1770	1880	2000	2110	2210	2340	2440	2570	2700	2800	2930	3080	3210
2580	1160	1260	1370	1470	1570	1680	1780	1880	2010	2120	2220	2350	2450	2580	2710	2810	2940	3100	3230
2590	1170	1270	1370	1480	1580	1680	1790	1890	2020	2120	2230	2360	2460	2590	2720	2820	2950	3110	3240
2600	1170	1270	1380	1480	1590	1690	1790	1900	2030	2130	2240	2370	2470	2600	2730	2830	2960	3120	3250
2610	1170	1280	1380	1490	1590	1700	1800	1910	2040	2140	2240	2380	2480	2610	2740	2840	2980	3130	3260
2620	1180	1280	1390	1490	1600	1700	1810	1910	2040	2150	2250	2380	2490	2620	2750	2860	2990	3140	3280
2630	1180	1290	1390	1500	1600	1710	1810	1920	2050	2160	2260	2390	2500	2630	2760	2870	3000	3160	3290
2640	1190	1290	1400	1500	1610	1720	1820	1930	2060	2160	2270	2400	2510	2640	2770	2880	3010	3170	3300
2650	1190	1300	1400	1510	1620	1720	1830	1930	2070	2170	2280	2410	2520	2650	2780	2890	3020	3180	3310
2660	1200	1300	1410	1520	1620	1730	1840	1940	2070	2180	2290	2420	2530	2660	2790	2900	3030	3190	3330
2670	1200	1310	1420	1520	1630	1740	1840	1950	2080	2190	2300	2430	2540	2670	2800	2910	3040	3200	3340
2680	1210	1310	1420	1530	1630	1740	1850	1960	2090	2200	2300	2440	2550	2680	2810	2920	3060	3220	3350
2690	1210	1320	1430	1530	1640	1750	1860	1960	2100	2210	2310	2450	2560	2690	2820	2930	3070	3230	3360
2700	1220	1320	1430	1540	1650	1760	1860	1970	2110	2210	2320	2460	2570	2700	2840	2940	3080	3240	3380
2710	1220	1330	1440	1540	1650	1760	1870	1980	2110	2220	2330	2470	2570	2710	2850	2950	3090	3250	3390
2720	1220	1330	1440	1550	1660	1770	1880	1990	2120	2230	2340	2480	2580	2720	2860	2960	3100	3260	3400
2730	1230	1340	1450	1560	1670	1770	1880	1990	2130	2240	2350	2480	2590	2730	2870	2980	3110	3280	3410
2740	1230	1340	1450	1560	1670	1780	1890	2000	2140	2250	2360	2490	2600	2740	2880	2990	3120	3290	3430
2750	1240	1350	1460	1570	1680	1790	1900	2010	2150	2260	2370	2500	2610	2750	2890	3000	3140	3300	3440
2760	1240	1350	1460	1570	1680	1790	1900	2010	2150	2260	2370	2510	2620	2760	2900	3010	3150	3310	3450
2770	1250	1360	1470	1580	1690	1800	1910	2020	2160	2270	2380	2520	2630	2770	2910	3020	3160	3320	3460
2780	1250	1360	1470	1580	1700	1810	1920	2030	2170	2280	2390	2530	2640	2780	2920	3030	3170	3340	3480
2790	1260	1370	1480	1590	1700	1810	1930	2040	2180	2290	2400	2540	2650	2790	2930	3040	3180	3350	3490
2800	1260	1370	1480	1600	1710	1820	1930	2040	2180	2300	2410	2550	2660	2800	2940	3050	3190	3360	3500
2810	1260	1380	1490	1600	1710	1830	1940	2050	2190	2300	2420	2560	2670	2810	2950	3060	3200	3370	3510
2820	1270	1380	1490	1610	1720	1830	1950	2060	2200	2310	2430	2570	2680	2820	2960	3070	3210	3380	3530
2830	1270	1390	1500	1610	1730	1840	1950	2070	2210	2320	2430	2580	2690	2830	2970	3080	3220	3400	3540
2840	1280	1390	1510	1620	1730	1850	1960	2070	2220	2330	2440	2580	2700	2840	2980	3100	3240	3410	3550
2850	1280	1400	1510	1620	1740	1850	1970	2080	2220	2340	2450	2590	2710	2850	2990	3110	3250	3420	3560
2860	1290	1400	1520	1630	1740	1860	1970	2090	2230	2350	2460	2600	2720	2860	3000	3120	3260	3430	3580
2870	1290	1410	1520	1640	1750	1870	1980	2100	2240	2350	2470	2610	2730	2870	3010	3130	3270	3440	3590
2880	1300	1410	1530	1640	1760	1870	1990	2100	2250	2360	2480	2620	2740	2880	3020	3140	3280	3460	3600
2890	1300	1420	1530	1650	1760	1880	1990	2110	2250	2370	2490	2630	2750	2890	3030	3150	3290	3470	3610
2900	1310	1420	1540	1650	1770	1890	2000	2120	2260	2380	2490	2640	2760	2900	3050	3160	3310	3480	3630
2910	1310	1430	1540	1660	1780	1890	2010	2120	2270	2390	2500	2650	2760	2910	3060	3170	3320	3490	3640
2920	1310	1430	1550	1660	1780	1900	2010	2130	2280	2390	2510	2660	2770	2920	3070	3180	3330	3500	3650
2930	1320	1440	1550	1670	1790	1900	2020	2140	2290	2400	2520	2670	2780	2930	3080	3190	3340	3520	3660
2940	1320	1440	1560	1680	1790	1910	2030	2150	2290	2410	2530	2680	2790	2940	3090	3200	3350	3530	3680
2950	1330	1450	1560	1680	1800	1920	2040	2150	2300	2420	2540	2680	2800	2950	3100	3220	3360	3540	3690
2960	1330	1450	1570	1690	1810	1920	2040	2160	2310	2430	2550	2690	2810	2960	3110	3230	3370	3550	3700
2970	1340	1460	1570	1690	1810	1930	2050	2170	2320	2440	2550	2700	2820	2970	3120	3240	3390	3560	3710
2980	1340	1460	1580	1700	1820	1940	2060	2180	2320	2440	2560	2710	2830	2980	3130	3250	3400	3580	3730
2990	1350	1470	1580	1700	1820	1940	2060	2180	2330	2450	2570	2720	2840	2990	3140	3260	3410	3590	3740
	150	155	160	165	170	175	180	185	190	195	200	205	210	215	220	225	230	235	240

AHRI Steam Rating, Btu/h-ft	TABLE F (cont.). AHRI Water Ratings at Average Water Temperature, Btu/h-ft																		
	150	155	160	165	170	175	180	185	190	195	200	205	210	215	220	225	230	235	240
3000	1350	1470	1590	1710	1830	1950	2070	2190	2340	2460	2580	2730	2850	3000	3150	3270	3420	3600	3750
3010	1350	1470	1600	1720	1840	1960	2080	2200	2350	2470	2590	2740	2860	3010	3160	3280	3430	3610	3760
3020	1360	1480	1600	1720	1840	1960	2080	2200	2360	2480	2600	2750	2870	3020	3170	3290	3440	3620	3780
3030	1360	1480	1610	1730	1850	1970	2090	2210	2360	2480	2610	2760	2880	3030	3180	3300	3450	3640	3790
3040	1370	1490	1610	1730	1850	1980	2100	2220	2370	2490	2610	2770	2890	3040	3190	3310	3470	3650	3800
3050	1370	1490	1620	1740	1860	1980	2100	2230	2380	2500	2620	2780	2900	3050	3200	3320	3480	3660	3810
3060	1380	1500	1620	1740	1870	1990	2110	2230	2390	2510	2630	2780	2910	3060	3210	3340	3490	3670	3830
3070	1380	1500	1630	1750	1870	2000	2120	2240	2390	2520	2640	2790	2920	3070	3220	3350	3500	3680	3840
3080	1390	1510	1630	1760	1880	2000	2130	2250	2400	2530	2650	2800	2930	3080	3230	3360	3510	3700	3850
3090	1390	1510	1640	1760	1880	2010	2130	2260	2410	2530	2660	2810	2940	3090	3240	3370	3520	3710	3860
3100	1400	1520	1640	1770	1890	2020	2140	2260	2420	2540	2670	2820	2950	3100	3250	3380	3530	3720	3880
3110	1400	1520	1650	1770	1900	2020	2150	2270	2430	2550	2670	2830	2950	3110	3260	3390	3550	3730	3890
3120	1400	1530	1650	1780	1900	2030	2150	2280	2430	2560	2680	2840	2960	3120	3280	3400	3560	3740	3900
3130	1410	1530	1660	1780	1910	2030	2160	2280	2440	2570	2690	2850	2970	3130	3290	3410	3570	3760	3910
3140	1410	1540	1660	1790	1920	2040	2170	2290	2450	2570	2700	2860	2980	3140	3300	3420	3580	3770	3930
3150	1420	1540	1670	1800	1920	2050	2170	2300	2460	2580	2710	2870	2990	3150	3310	3430	3590	3780	3940
3160	1420	1550	1670	1800	1930	2050	2180	2310	2470	2590	2720	2880	3000	3160	3320	3440	3600	3790	3950
3170	1430	1550	1680	1810	1930	2060	2190	2310	2470	2600	2730	2890	3010	3170	3330	3460	3610	3800	3960
3180	1430	1560	1690	1810	1940	2070	2190	2320	2480	2610	2730	2890	3020	3180	3340	3470	3630	3820	3980
3190	1440	1560	1690	1820	1950	2070	2200	2330	2490	2620	2740	2900	3030	3190	3350	3480	3640	3830	3990
3200	1440	1570	1700	1820	1950	2080	2210	2340	2500	2620	2750	2910	3040	3200	3360	3490	3650	3840	4000
3210	1440	1570	1700	1830	1960	2090	2210	2340	2500	2630	2760	2920	3050	3210	3370	3500	3660	3850	4010
3220	1450	1580	1710	1840	1960	2090	2220	2350	2510	2640	2770	2930	3060	3220	3380	3510	3670	3860	4030
3230	1450	1580	1710	1840	1970	2100	2230	2360	2520	2650	2780	2940	3070	3230	3390	3520	3680	3880	4040
3240	1460	1590	1720	1850	1980	2110	2240	2370	2530	2660	2790	2950	3080	3240	3400	3530	3690	3890	4050
3250	1460	1590	1720	1850	1980	2110	2240	2370	2540	2670	2800	2960	3090	3250	3410	3540	3710	3900	4060
3260	1470	1600	1730	1860	1990	2120	2250	2380	2540	2670	2800	2970	3100	3260	3420	3550	3720	3910	4080
3270	1470	1600	1730	1860	1990	2130	2260	2390	2550	2680	2810	2980	3110	3270	3430	3560	3730	3920	4090
3280	1480	1610	1740	1870	2000	2130	2260	2390	2560	2690	2820	2980	3120	3280	3440	3580	3740	3940	4100
3290	1480	1610	1740	1880	2010	2140	2270	2400	2570	2700	2830	2990	3130	3290	3450	3590	3750	3950	4110
3300	1490	1620	1750	1880	2010	2150	2280	2410	2570	2710	2840	3000	3140	3300	3460	3600	3760	3960	4130
3310	1490	1620	1750	1890	2020	2150	2280	2420	2580	2710	2850	3010	3140	3310	3480	3610	3770	3970	4140
3320	1490	1630	1760	1890	2030	2160	2290	2420	2590	2720	2860	3020	3150	3320	3490	3620	3780	3980	4150
3330	1500	1630	1760	1900	2030	2160	2300	2430	2600	2730	2860	3030	3160	3330	3500	3630	3800	4000	4160
3340	1500	1640	1770	1900	2040	2170	2300	2440	2610	2740	2870	3040	3170	3340	3510	3640	3810	4010	4180
3350	1510	1640	1780	1910	2040	2180	2310	2450	2610	2750	2880	3050	3180	3350	3520	3650	3820	4020	4190
3360	1510	1650	1780	1920	2050	2180	2320	2450	2620	2760	2890	3060	3190	3360	3530	3660	3830	4030	4200
3370	1520	1650	1790	1920	2060	2190	2330	2460	2630	2770	2900	3070	3200	3370	3540	3670	3840	4040	4210
3380	1520	1660	1790	1930	2060	2200	2330	2470	2640	2770	2910	3080	3210	3380	3550	3680	3850	4060	4230
3390	1530	1660	1800	1930	2070	2200	2340	2470	2640	2780	2920	3080	3220	3390	3560	3700	3860	4070	4240
3400	1530	1670	1800	1940	2070	2210	2350	2480	2650	2790	2920	3090	3230	3400	3570	3710	3880	4080	4250
3410	1530	1670	1810	1940	2080	2220	2350	2490	2660	2800	2930	3100	3240	3410	3580	3720	3890	4090	4260
3420	1540	1680	1810	1950	2090	2220	2360	2500	2670	2800	2940	3110	3250	3420	3590	3730	3900	4100	4280
3430	1540	1680	1820	1960	2090	2230	2370	2500	2680	2810	2950	3120	3260	3430	3600	3740	3910	4120	4290
3440	1550	1690	1820	1960	2100	2240	2370	2510	2680	2820	2960	3130	3270	3440	3610	3750	3920	4130	4300
3450	1550	1690	1830	1970	2100	2240	2380	2520	2690	2830	2970	3140	3280	3450	3620	3760	3930	4140	4310
3460	1560	1700	1830	1970	2110	2250	2390	2530	2700	2840	2980	3150	3290	3460	3630	3770	3940	4150	4330
3470	1560	1700	1840	1980	2120	2260	2390	2530	2710	2850	2990	3160	3300	3470	3640	3780	3960	4160	4340
3480	1570	1710	1840	1980	2120	2260	2400	2540	2710	2850	2990	3170	3310	3480	3650	3790	3970	4180	4350
3490	1570	1710	1850	1990	2130	2270	2410	2550	2720	2860	3000	3180	3320	3490	3660	3800	3980	4190	4360
3500	1580	1720	1860	2000	2140	2280	2420	2560	2730	2870	3010	3190	3330	3500	3680	3820	3990	4200	4380
3510	1580	1720	1860	2000	2140	2280	2420	2560	2740	2880	3020	3190	3330	3510	3690	3830	4000	4210	4390
3520	1580	1720	1870	2010	2150	2290	2430	2570	2750	2890	3030	3200	3340	3520	3700	3840	4010	4220	4400
3530	1590	1730	1870	2010	2150	2290	2440	2580	2750	2890	3040	3210	3350	3530	3710	3850	4020	4240	4410
3540	1590	1730	1880	2020	2160	2300	2440	2580	2760	2900	3040	3220	3360	3540	3720	3860	4040	4250	4430
3550	1600	1740	1880	2020	2170	2310	2450	2590	2770	2910	3050	3230	3370	3550	3730	3870	4050	4260	4440
3560	1600	1740	1890	2030	2170	2310	2460	2600	2780	2920	3060	3240	3380	3560	3740	3880	4060	4270	4450
3570	1610	1750	1890	2030	2180	2320	2660	2610	2790	2930	3070	3250	3390	3570	3750	3890	4070	4280	4460
3580	1610	1750	1900	2040	2180	2330	2470	2610	2790	2940	3080	3260	3400	3580	3760	3900	4080	4300	4480
3590	1620	1760	1900	2050	2190	2330	2480	2620	2800	2940	3090	3270	3410	3590	3770	3910	4090	4310	4490
	150	155	160	165	170	175	180	185	190	195	200	205	210	215	220	225	230	235	240

AHRI Steam Rating, Btu/h-ft	TABLE F (cont.). AHRI Water Ratings at Average Water Temperature, Btu/h-ft																		
	150	155	160	165	170	175	180	185	190	195	200	205	210	215	220	225	230	235	240
3600	1620	1760	1910	2050	2200	2340	2480	2630	2810	2950	3100	3280	3420	3600	3780	3920	4100	4320	4500
3610	1620	1770	1910	2060	2200	2350	2490	2640	2820	2960	3100	3290	3430	3610	3790	3930	4120	4330	4510
3620	1630	1770	1920	2060	2210	2350	2500	2640	2820	2970	3110	3290	3440	3620	3800	3950	4130	4340	4530
3630	1630	1780	1920	2070	2210	2360	2500	2650	2830	2980	3120	3300	3450	3630	3810	3960	4140	4360	4540
3640	1640	1780	1930	2070	2220	2370	2510	2660	2840	2980	3130	3310	3460	3640	3820	3970	4150	4370	4550
3650	1640	1790	1930	2080	2230	2370	2520	2660	2850	2990	3140	3320	3470	3650	3830	3980	4160	4380	4560
3660	1650	1790	1940	2090	2230	2380	2530	2670	2850	3000	3150	3330	3480	3660	3840	3990	4170	4390	4580
3670	1650	1800	1950	2090	2240	2390	2530	2680	2860	3010	3160	3340	3490	3670	3850	4000	4180	4400	4590
3680	1660	1800	1950	2100	2240	2390	2540	2690	2870	3020	3160	3350	3500	3680	3860	4010	4200	4420	4600
3690	1660	1810	1960	2100	2250	2400	2550	2690	2880	3030	3170	3360	3510	3690	3870	4020	4210	4430	4610
3700	1670	1810	1960	2110	2260	2410	2550	2700	2890	3030	3180	3370	3520	3700	3890	4030	4220	4440	4630
3710	1670	1820	1970	2110	2260	2410	2560	2710	2890	3040	3190	3380	3520	3710	3900	4040	4230	4450	4640
3720	1670	1820	1970	2120	2270	2420	2570	2720	2900	3050	3200	3390	3530	3720	3910	4050	4240	4460	4650
3730	1680	1830	1980	2130	2280	2420	2570	2720	2910	3060	3210	3390	3540	3730	3920	4070	4250	4480	4660
3740	1680	1830	1980	2130	2280	2430	2580	2730	2920	3070	3220	3400	3550	3740	3930	4080	4260	4490	4680
3750	1690	1840	1990	2140	2290	2440	2590	2740	2930	3080	3230	3410	3560	3750	3940	4090	4280	4500	4690
3760	1690	1840	1990	2140	2290	2440	2590	2740	2930	3080	3230	3420	3570	3760	3950	4100	4290	4510	4700
3770	1700	1850	2000	2150	2300	2450	2600	2750	2940	3090	3240	3430	3580	3770	3960	4110	4300	4520	4710
3780	1700	1850	2000	2150	2310	2460	2610	2760	2950	3100	3250	3440	3590	3780	3970	4120	4310	4540	4730
3790	1710	1860	2010	2160	2310	2460	2620	2770	2960	3110	3260	3450	3600	3790	3980	4130	4320	4550	4740
3800	1710	1860	2010	2170	2320	2470	2620	2770	2960	3120	3270	3460	3610	3800	3990	4140	4330	4560	4750
3810	1710	1870	2020	2170	2320	2480	2630	2780	2970	3120	3280	3470	3620	3810	4000	4150	4340	4570	4760
3820	1720	1870	2020	2180	2330	2480	2640	2790	2980	3130	3290	3480	3630	3820	4010	4160	4350	4580	4780
3830	1720	1880	2030	2180	2340	2490	2640	2800	2990	3140	3290	3490	3640	3830	4020	4170	4370	4600	4790
3840	1730	1880	2040	2190	2340	2500	2650	2800	3000	3150	3300	3490	3650	3840	4030	4190	4380	4610	4800
3850	1730	1890	2040	2190	2350	2500	2660	2810	3000	3160	3310	3500	3660	3850	4040	4200	4390	4620	4810
3860	1740	1890	2050	2200	2350	2510	2660	2820	3010	3170	3320	3510	3670	3860	4050	4210	4400	4630	4830
3870	1740	1900	2050	2210	2360	2520	2670	2830	3020	3170	3330	3520	3680	3870	4060	4220	4410	4640	4840
3880	1750	1900	2060	2210	2370	2520	2680	2830	3030	3180	3340	3530	3690	3880	4070	4230	4420	4660	4850
3890	1750	1910	2060	2220	2370	2530	2680	2840	3030	3190	3350	3540	3700	3890	4080	4240	4430	4670	4860
3900	1760	1910	2070	2220	2380	2540	2690	2850	3040	3200	3350	3550	3710	3900	4100	4250	4450	4680	4880
3910	1760	1920	2070	2230	2390	2540	2700	2850	3050	3210	3360	3560	3710	3910	4110	4260	4460	4690	4890
3920	1760	1920	2080	2230	2390	2550	2700	2860	3060	3210	3370	3570	3720	3920	4120	4270	4470	4700	4900
3930	1770	1930	2080	2240	2400	2550	2710	2870	3070	3220	3380	3580	3730	3930	4130	4280	4480	4720	4910
3940	1770	1930	2090	2250	2400	2560	2720	2880	3070	3230	3390	3590	3740	3940	4140	4290	4490	4730	4930
3950	1780	1940	2090	2250	2410	2570	2730	2880	3080	3240	3400	3590	3750	3950	4150	4310	4500	4740	4940
3960	1780	1940	2100	2260	2420	2570	2730	2890	3090	3250	3410	3600	3760	3960	4160	4320	4510	4750	4950
3970	1790	1950	2100	2260	2420	2580	2740	2900	3100	3260	3410	3610	3770	3970	4170	4330	4530	4760	4960
3980	1790	1950	2110	2270	2430	2590	2750	2910	3100	3260	3420	3620	3780	3980	4180	4340	4540	4780	4980
3990	1800	1960	2110	2270	2430	2590	2750	2910	3110	3270	3430	3630	3790	3990	4190	4350	4550	4790	4990
4000	1800	1960	2120	2280	2440	2600	2760	2920	3120	3280	3440	3640	3800	4000	4200	4360	4560	4800	5000
4010	1800	1960	2130	2290	2450	2610	2770	2930	3130	3290	3450	3650	3810	4010	4210	4370	4570	4810	5010
4020	1810	1970	2130	2290	2450	2610	2770	2930	3140	3300	3460	3660	3820	4020	4220	4380	4580	4820	5030
4030	1810	1970	2140	2300	2460	2620	2780	2940	3140	3300	3470	3670	3830	4030	4230	4390	4590	4840	5040
4040	1820	1980	2140	2300	2460	2630	2790	2950	3150	3310	3470	3680	3840	4040	4240	4400	4610	4850	5050
4050	1820	1980	2150	2310	2470	2630	2790	2960	3160	3320	3480	3690	3850	4050	4250	4410	4620	4860	5060
4060	1830	1990	2150	2310	2480	2640	2800	2960	3170	3330	3490	3690	3860	4060	4260	4430	4630	4870	5080
4070	1830	1990	2160	2320	2480	2650	2810	2970	3170	3340	3500	3700	3870	4070	4270	4440	4640	4880	5090
4080	1840	2000	2160	2330	2490	2650	2820	2980	3180	3350	3510	3710	3880	4080	4280	4450	4650	4900	5100
4090	1840	2000	2170	2330	2490	2660	2820	2990	3190	3350	3520	3720	3890	4090	4290	4460	4660	4910	5110
4100	1850	2010	2170	2340	2500	2670	2830	2990	3200	3360	3530	3730	3900	4100	4310	4470	4670	4920	5130
4110	1850	2010	2180	2340	2510	2670	2840	3000	3210	3370	3530	3740	3900	4110	4320	4480	4690	4930	5140
4120	1850	2020	2180	2350	2510	2670	2840	3010	3210	3380	3540	3750	3910	4120	4330	4490	4700	4940	5150
4130	1860	2020	2190	2350	2520	2680	2850	3010	3220	3390	3550	3760	3920	4130	4340	4500	4710	4960	5160
4140	1860	2030	2190	2360	2530	2690	2860	3020	3230	3390	3560	3770	3930	4140	4350	4510	4720	4970	5180
4150	1870	2030	2200	2370	2530	2700	2860	3030	3240	3400	3570	3780	3940	4150	4360	4520	4730	4980	5190
4160	1870	2040	2200	2370	2540	2700	2870	3040	3240	3410	3580	3790	3950	4160	4370	4530	4740	4990	5200
4170	1880	2040	2210	2380	2540	2710	2880	3040	3250	3420	3590	3790	3960	4170	4380	4550	4750	5000	5210
4180	1880	2050	2220	2380	2550	2720	2880	3050	3260	3430	3590	3800	3970	4180	4390	4560	4770	5020	5230
4190	1890	2050	2220	2390	2560	2720	2890	3060	3270	3440	3600	3810	3980	4190	4400	4570	4780	5030	5240
	150	155	160	165	170	175	180	185	190	195	200	205	210	215	220	225	230	235	240

APPENDIX G – TABLES FOR DETERMINING RATINGS FOR FLAT TOP COVERS BASED ON THE AHRI STEAM RATING - INFORMATIVE

RATINGS FOR FLAT TOP COVERS

If the element is sold with a flat top Cover,

The rating may be determined by applying the following factors in Equation G1 to the AHRI Steam Rating for the bare element unit. (Use Table G for calculations.)

One Tier	0.90
Two Tiers	0.85
Three Tiers	0.80

Provided the ratio of free area of the grille to the projected area of the fins is not less than sixty percent (60%). This ratio shall be determined by the following formula:

$$R_1 = \frac{G_{Area}}{H_f \cdot 12} \qquad \qquad \qquad G1$$

where:

- G_{area} = Free area of the grille, in²/ft
- H_f = Horizontal width of fin, in
- R_1 = Ratio of free area of the grille to the projected area of the fins

Note: The free area of the grille shall not include the opening between the wall and the Cover, plus the square inches of grille per foot

TO USE THIS TABLE: Select the correct portion of the table as determined by the number of tiers applicable to the rating desired. Enter the left-hand column at the bare element steam rating and immediately to the right read the flat top cover steam rating.

TABLE G. Flat Top Cover Steam Ratings, Btu/h·ft											
ONE TIER (0.90)				TWO TIERS (0.85)							
Bare Element AHRI Rating	Flat Top Cover Rating	Bare Element AHRI Rating	Flat Top Cover Rating	Bare Element AHRI Rating	Flat Top Cover Rating	Bare Element AHRI Rating	Flat Top Cover Rating	Bare Element AHRI Rating	Flat Top Cover Rating	Bare Element AHRI Rating	Flat Top Cover Rating
600	540	1260	1130	1260	1070	1920	1630	2580	2190		
610	550	1270	1140	1270	1080	1930	1640	2590	2200		
620	560	1280	1150	1280	1090	1940	1650	2600	2210		
630	570	1290	1160	1290	1100	1950	1660	2610	2220		
640	580	1300	1170	1300	1110	1960	1670	2620	2230		
650	590	1310	1180	1310	1110	1970	1670	2630	2240		
660	590	1320	1190	1320	1120	1980	1680	2640	2240		
670	600	1330	1200	1330	1130	1990	1690	2650	2250		
680	610	1340	1210	1340	1140	2000	1700	2660	2260		
690	620	1350	1220	1350	1150	2010	1710	2670	2270		
700	630	1360	1220	1360	1160	2020	1720	2680	2280		
710	640	1370	1230	1370	1160	2030	1730	2690	2290		
720	650	1380	1240	1380	1170	2040	1730	2700	2300		
730	660	1390	1250	1390	1180	2050	1740	2710	2300		
740	670	1400	1260	1400	1190	2060	1750	2720	2310		
750	680	1410	1270	1410	1200	2070	1760	2730	2320		
760	680	1420	1280	1420	1210	2080	1770	2740	2330		
770	690	1430	1290	1430	1220	2090	1780	2750	2340		
780	700	1440	1300	1440	1220	2100	1790	2760	2350		
790	710	1450	1310	1450	1230	2110	1790	2770	2350		
800	720	1460	1310	1460	1240	2120	1800	2780	2360		
810	730	1470	1320	1470	1250	2130	1810	2790	2370		
820	740	1480	1330	1480	1260	2140	1820	2800	2380		
830	750	1490	1340	1490	1270	2150	1830	2810	2390		
840	760	1500	1350	1500	1280	2160	1840	2820	2400		
850	770	1510	1360	1510	1280	2170	1840	2830	2410		
860	770	1520	1370	1520	1290	2180	1850	2840	2410		
870	780	1530	1380	1530	1300	2190	1860	2850	2420		
880	790	1540	1390	1540	1310	2200	1870	2860	2430		
890	800	1550	1400	1550	1320	2210	1880	2870	2440		
900	810	1560	1400	1560	1330	2220	1890	2880	2450		
910	820	1570	1410	1570	1330	2230	1900	2890	2460		
920	830	1580	1420	1580	1340	2240	1900	2900	2470		
930	840	1590	1430	1590	1350	2250	1910	2910	2470		
940	850	1600	1440	1600	1360	2260	1920	2920	2480		
950	860	1610	1450	1610	1370	2270	1930	2930	2490		
960	860	1620	1460	1620	1380	2280	1940	2940	2500		
970	870	1630	1470	1630	1390	2290	1950	2950	2510		
980	880	1640	1480	1640	1390	2300	1960	2960	2520		
990	890	1650	1490	1650	1400	2310	1960	2970	2520		
1000	900	1660	1490	1660	1410	2320	1970	2980	2530		
1010	910	1670	1500	1670	1420	2330	1980	2990	2540		
1020	920	1680	1510	1680	1430	2340	1990	3000	2550		
1030	930	1690	1520	1690	1440	2350	2000	3010	2560		
1040	940	1700	1530	1700	1450	2360	2010	3020	2570		
1050	950	1710	1540	1710	1450	2370	2010	3030	2580		
1060	950	1720	1550	1720	1460	2380	2020	3040	2580		
1070	960	1730	1560	1730	1470	2390	2030	3050	2590		
1080	970	1740	1570	1740	1480	2400	2040	3060	2600		
1090	980	1750	1580	1750	1490	2410	2050	3070	2610		
1100	990	1760	1580	1760	1500	2420	2060	3080	2620		
1110	1000	1770	1590	1770	1500	2430	2070	3090	2630		
1120	1010	1780	1600	1780	1510	2440	2070	3100	2640		
1130	1020	1790	1610	1790	1520	2450	2080	3110	2640		
1140	1030	1800	1620	1800	1530	2460	2090	3120	2650		
1150	1040	1810	1630	1810	1540	2470	2100	3130	2660		
1160	1040	1820	1640	1820	1550	2480	2110	3140	2670		
1170	1050	1830	1650	1830	1560	2490	2120	3150	2680		
1180	1060	1840	1660	1840	1560	2500	2130	3160	2690		
1190	1070	1850	1670	1850	1570	2510	2130	3170	2690		
1200	1080	1860	1670	1860	1580	2520	2140	3180	2700		
1210	1090	1870	1680	1870	1590	2530	2150	3190	2710		
1220	1100	1880	1690	1880	1600	2540	2160	3200	2720		
1230	1110	1890	1700	1890	1610	2550	2170	3210	2730		
1240	1120	1900	1710	1900	1620	2560	2180	3220	2740		
1250	1130	1910	1720	1910	1620	2570	2180	3230	2750		

APPENDIX H – TABLES FOR DETERMINING RATINGS FOR EXPANDED METAL COVERS BASED ON THE AHRI STEAM RATING OF A BARE ELEMENT - INFORMATIVE

If the element is sold with an Expanded Metal Cover,

The rating may be determined by applying the following factors in Equation H1 to the AHRI steam Output Heating Capacity of a bare element unit. (Use Table H for calculations.)

$$H_{exp} = H_{out} \cdot C_{exp} \qquad \text{H1}$$

where:

- C_{exp} = Expanded Metal Cover Factor, unitless
- H_{exp} = Heating Capacity of an Expanded Metal Cover, Btu/h·ft
- H_{out} = AHRI Steam Output Heating Capacity, Btu/h·ft

TO USE THIS TABLE: Enter the left-hand column at the bare element steam rating. Proceed to the right to the column headed by the correct expanded metal cover factor, as shown in the manufacturer's listing, and read the expanded metal cover steam rating.

TABLE H. Expanded Metal Cover Steam Ratings, Btu/h·ft

Bare Element AHRI Rating	Expanded Metal Cover Rating				Bare Element AHRI Rating	Expanded Metal Cover Rating				Bare Element AHRI Rating	Expanded Metal Cover Rating			
	0.96 factor	0.964 factor	0.97 factor	0.974 factor		0.96 factor	0.964 factor	0.97 factor	0.974 factor		0.96 factor	0.964 factor	0.97 factor	0.974 factor
600	580	580	580	580	1200	1150	1160	1160	1170	1800	1730	1740	1750	1750
610	590	590	590	590	1210	1160	1170	1170	1180	1810	1740	1740	1760	1760
620	600	600	600	600	1220	1170	1180	1180	1190	1820	1750	1750	1770	1770
630	600	610	610	610	1230	1180	1190	1190	1200	1830	1760	1760	1780	1780
640	610	620	620	620	1240	1190	1200	1200	1210	1840	1770	1770	1780	1790
650	620	630	630	630	1250	1200	1210	1210	1220	1850	1780	1780	1790	1800
660	630	640	640	640	1260	1210	1210	1220	1230	1860	1790	1790	1800	1810
670	640	650	650	650	1270	1220	1220	1230	1240	1870	1800	1800	1810	1820
680	650	660	660	660	1280	1230	1230	1240	1250	1880	1800	1810	1820	1830
690	660	670	670	670	1290	1240	1240	1250	1260	1890	1810	1820	1830	1840
700	670	670	680	680	1300	1250	1250	1260	1270	1900	1820	1830	1840	1850
710	680	680	690	690	1310	1260	1260	1270	1280	1910	1830	1840	1850	1860
720	690	690	700	700	1320	1270	1270	1280	1290	1920	1840	1850	1860	1870
730	700	700	710	710	1330	1280	1280	1290	1300	1930	1850	1860	1870	1880
740	710	710	720	720	1340	1290	1290	1300	1310	1940	1860	1870	1880	1890
750	720	720	730	730	1350	1300	1300	1310	1310	1950	1870	1880	1890	1900
760	730	730	740	740	1360	1310	1310	1320	1320	1960	1880	1890	1900	1910
770	740	740	750	750	1370	1320	1320	1330	1330	1970	1890	1900	1910	1920
780	750	750	760	760	1380	1320	1330	1340	1340	1980	1900	1910	1920	1930
790	760	760	770	770	1390	1330	1340	1350	1350	1990	1910	1920	1930	1940
800	770	770	780	780	1400	1340	1350	1360	1360	2000	1920	1930	1940	1950
810	780	780	790	790	1410	1350	1360	1370	1370	2010	1930	1940	1950	1960
820	790	790	800	800	1420	1360	1370	1380	1380	2020	1940	1950	1960	1970
830	800	800	810	810	1430	1370	1380	1390	1390	2030	1950	1960	1970	1980
840	810	810	810	820	1440	1380	1390	1400	1400	2040	1960	1970	1980	1990
850	820	820	820	830	1450	1390	1400	1410	1410	2050	1970	1980	1990	2000
860	830	830	830	840	1460	1400	1410	1420	1420	2060	1980	1990	2000	2010
870	840	840	840	850	1470	1410	1420	1430	1430	2070	1990	2000	2010	2020
880	840	850	850	860	1480	1420	1430	1440	1440	2080	2000	2010	2020	2030
890	850	860	860	870	1490	1430	1440	1450	1450	2090	2010	2010	2030	2040
900	860	870	870	880	1500	1440	1450	1460	1460	2100	2020	2020	2040	2050
910	870	880	880	890	1510	1450	1460	1460	1470	2110	2030	2030	2050	2060
920	880	890	890	900	1520	1460	1470	1470	1480	2120	2040	2040	2060	2060
930	890	900	900	910	1530	1470	1470	1480	1490	2130	2040	2050	2070	2070
940	900	910	910	920	1540	1480	1480	1490	1500	2140	2050	2060	2080	2080
950	910	920	920	930	1550	1490	1490	1500	1510	2150	2060	2070	2090	2090
960	920	930	930	940	1560	1500	1500	1510	1520	2160	2070	2080	2100	2100
970	930	940	940	940	1570	1510	1510	1520	1530	2170	2080	2090	2100	2110
980	940	940	950	950	1580	1520	1520	1530	1540	2180	2090	2100	2110	2120
990	950	950	960	960	1590	1530	1530	1540	1550	2190	2100	2110	2120	2130
1000	960	960	970	970	1600	1540	1540	1550	1560	2200	2110	2120	2130	2140
1010	970	970	980	980	1610	1550	1550	1560	1570	2210	2120	2130	2140	2150
1020	980	980	990	990	1620	1560	1560	1570	1580	2220	2130	2140	2150	2160
1030	990	990	1000	1000	1630	1560	1570	1580	1590	2230	2140	2150	2160	2170
1040	1000	1000	1010	1010	1640	1570	1580	1590	1600	2240	2150	2160	2170	2180
1050	1010	1010	1020	1020	1650	1580	1590	1600	1610	2250	2160	2170	2180	2190
1060	1020	1020	1030	1030	1660	1590	1600	1610	1620	2260	2170	2180	2190	2200
1070	1030	1030	1040	1040	1670	1600	1610	1620	1630	2270	2180	2190	2200	2210
1080	1040	1040	1050	1050	1680	1610	1620	1630	1640	2280	2190	2200	2210	2220
1090	1050	1050	1060	1060	1690	1620	1630	1640	1650	2290	2200	2210	2220	2230
1100	1060	1060	1070	1070	1700	1630	1640	1650	1660	2300	2210	2220	2230	2240
1110	1070	1070	1080	1080	1710	1640	1650	1660	1670	2310	2220	2230	2240	2250
1120	1080	1080	1090	1090	1720	1650	1660	1670	1680	2320	2230	2240	2250	2260
1130	1080	1090	1100	1100	1730	1660	1670	1680	1690	2330	2240	2250	2260	2270
1140	1090	1100	1110	1110	1740	1670	1680	1690	1690	2340	2250	2260	2270	2280
1150	1100	1110	1120	1120	1750	1680	1690	1700	1700	2350	2260	2270	2280	2290
1160	1100	1120	1130	1130	1760	1690	1700	1710	1710	2360	2270	2280	2290	2300
1170	1120	1130	1130	1140	1770	1700	1710	1720	1720	2370	2280	2280	2300	2310
1180	1130	1140	1140	1150	1780	1710	1720	1730	1730	2380	2280	2290	2310	2320
1190	1140	1150	1150	1160	1790	1720	1730	1740	1740	2390	2290	2300	2320	2330
—	0.96	0.964	0.97	0.974	—	0.96	0.964	0.970	0.974	—	0.96	0.964	0.97	0.974

TABLE H (cont). Expanded Metal Cover Steam Ratings, Btu/h-ft

Bare Element AHRI Rating	Expanded Metal Cover Rating				Bare Element AHRI Rating	Expanded Metal Cover Rating				Bare Element AHRI Rating	Expanded Metal Cover Rating			
	0.96 factor	0.964 factor	0.97 factor	0.974 factor		0.96 factor	0.964 factor	0.97 factor	0.974 factor		0.96 factor	0.964 factor	0.97 factor	0.974 factor
2400	2300	2310	2330	2340	3000	2880	2890	2910	2920	3600	3460	3470	3490	3510
2410	2310	2320	2340	2350	3010	2890	2900	2920	2930	3610	3470	3480	3500	3520
2420	2320	2330	2350	2360	3020	2900	2910	2930	2940	3620	3480	3490	3510	3530
2430	2330	2340	2360	2370	3030	2910	2920	2940	2950	3630	3480	3500	3520	3540
2440	2340	2350	2370	2380	3040	2920	2930	2950	2960	3640	3490	3510	3530	3550
2450	2350	2360	2380	2390	3050	2930	2940	2960	2970	3650	3500	3520	3540	3560
2460	2360	2370	2390	2400	3060	2940	2950	2970	2980	3660	3510	3530	3550	3560
2470	2370	2380	2400	2410	3070	2950	2960	2980	2990	3670	3520	3540	3560	3570
2480	2380	2390	2410	2420	3080	2960	2970	2990	3000	3680	3530	3550	3570	3580
2490	2390	2400	2420	2430	3090	2970	2980	3000	3010	3690	3540	3560	3580	3590
2500	2400	2410	2430	2440	3100	2980	2990	3010	3020	3700	3550	3570	3590	3600
2510	2410	2420	2430	2440	3110	2990	3000	3020	3030	3710	3560	3580	3600	3610
2520	2420	2430	2440	2450	3120	3000	3010	3030	3040	3720	3570	3590	3610	3620
2530	2430	2440	2450	2460	3130	3000	3020	3040	3050	3730	3580	3600	3620	3630
2540	2440	2450	2460	2470	3140	3010	3030	3050	3060	3740	3590	3610	3630	3640
2550	2450	2460	2470	2480	3150	3020	3040	3060	3070	3750	3600	3620	3640	3650
2560	2460	2470	2480	2490	3160	3030	3050	3070	3080	3760	3610	3620	3650	3660
2570	2470	2480	2490	2500	3170	3040	3060	3070	3090	3770	3620	3630	3660	3670
2580	2480	2490	2500	2510	3180	3050	3070	3080	3100	3780	3630	3640	3670	3680
2590	2490	2500	2510	2520	3190	3060	3080	3090	3110	3790	3640	3650	3680	3690
2600	2500	2510	2520	2530	3200	3070	3080	3100	3120	3800	3650	3660	3690	3700
2610	2510	2520	2530	2540	3210	3080	3090	3110	3130	3810	3660	3670	3700	3710
2620	2520	2530	2540	2550	3220	3090	3100	3120	3140	3820	3670	3680	3710	3720
2630	2520	2540	2550	2560	3230	3100	3110	3130	3150	3830	3680	3690	3720	3730
2640	2530	2540	2560	2570	3240	3110	3120	3140	3160	3840	3690	3700	3720	3740
2650	2540	2550	2570	2580	3250	3120	3130	3150	3170	3850	3700	3710	3730	3750
2660	2550	2560	2580	2590	3260	3130	3140	3160	3180	3860	3710	3720	3740	3760
2670	2560	2570	2590	2600	3270	3140	3150	3170	3180	3870	3720	3730	3750	3770
2780	2570	2580	2600	2610	3280	3150	3160	3180	3190	3880	3720	3740	3760	3780
2690	2580	2590	2610	2620	3290	3160	3170	3190	3200	3890	3730	3750	3770	3790
2700	2590	2600	2620	2630	3300	3170	3180	3200	3210	3900	3740	3760	3780	3800
2710	2600	2610	2630	2640	3310	3180	3190	3210	3220	3910	3750	3770	3790	3810
2720	2610	2620	2640	2650	3320	3190	3200	3220	3230	3920	3760	3780	3800	3820
2730	2620	2630	2650	2660	3330	3200	3210	3230	3240	3930	3770	3790	3810	3830
2740	2630	2640	2660	2670	3340	3210	3220	3240	3250	3940	3780	3800	3820	3840
2750	2640	2650	2670	2680	3350	3220	3230	3250	3260	3950	3790	3810	3830	3850
2760	2650	2660	2680	2690	3360	3230	3240	3260	3270	3960	3800	3820	3840	3860
2770	2660	2670	2690	2700	3370	3240	3250	3270	3280	3970	3810	3830	3850	3870
2780	2670	2680	2700	2710	3380	3240	3260	3280	3290	3980	3820	3840	3860	3880
2790	2680	2690	2710	2720	3390	3250	3270	3290	3300	3990	3830	3850	3870	3890
2800	2690	2700	2720	2730	3400	3260	3280	3300	3310	4000	3840	3860	3880	3900
2810	2700	2710	2730	2740	3410	3270	3290	3310	3320	4010	3850	3870	3890	3910
2820	2710	2720	2740	2750	3420	3280	3300	3320	3330	4020	3860	3880	3900	3920
2830	2720	2730	2750	2760	3430	3290	3310	3330	3340	4030	3870	3880	3910	3930
2840	2730	2740	2750	2770	3440	3300	3320	3340	3350	4040	3880	3890	3920	3930
2850	2740	2750	2760	2780	3450	3310	3330	3350	3360	4050	3890	3900	3930	3940
2860	2750	2760	2770	2790	3460	3320	3340	3360	3370	4060	3900	3910	3940	3950
2870	2760	2770	2780	2800	3470	3330	3350	3370	3380	4070	3910	3920	3950	3960
2880	2760	2780	2790	2810	3480	3340	3350	3380	3390	4080	3920	3930	3960	3970
2890	2770	2790	2800	2810	3490	3350	3360	3390	3400	4090	3930	3940	3970	3980
2900	2780	2800	2810	2820	3500	3360	3370	3400	3410	4100	3940	3950	3980	3990
2910	2790	2810	2820	2830	3510	3370	3380	3400	3420	4110	3950	3960	3990	4000
2920	2800	2810	2830	2840	3520	3380	3390	3410	3430	4120	3960	3970	4000	4010
2930	2810	2820	2840	2850	3530	3390	3400	3420	3440	4130	3960	3980	4010	4020
2940	2820	2830	2850	2860	3540	3400	3410	3430	3450	4140	3970	3990	4020	4030
2950	2830	2840	2860	2870	3550	3410	3420	3440	3460	4150	3980	4000	4030	4040
2960	2840	2850	2870	2880	3560	3420	3430	3450	3470	4160	3990	4010	4040	4050
2970	2850	2860	2880	2890	3570	3430	3440	3460	3480	4170	4000	4020	4040	4060
2980	2860	2870	2890	2900	3580	3440	3450	3470	3490	4180	4010	4030	4050	4070
2990	2870	2880	2900	2910	3590	3450	3460	3480	3500	4190	4020	4040	4060	4080
—	0.96	0.964	0.97	0.974	—	0.96	0.964	0.97	0.974	—	0.96	0.964	0.97	0.974

APPENDIX I – SAMPLE TEST REPORTS/DATA SHEETS – INFORMATIVE

Hydronics Institute Section of AHRI		
DIMENSIONAL DATA SHEET - INSTALLATION BARE - FORM CFTR-DS2		
Test Number:	Report Number:	
Finned Tube Name:	Catalog Designation:	
Element Designation:	Room Type:	
INSTALLATION BARE		
Construction of Finned Tube Element		
1.	Tube material and size	
2.	Fin material	
3.	Fin size (height, width, thickness)	
4.	Finish of fin	
5.	Method of bonding	
Details of Tested Unit		
6.	Catalog Designation	
7.	Total length of element, L_t	
8.	Active length of element, L_a	
9.	Number of fins in tested length	
10.	Number of fins per foot	
11.	Number of tiers	
12.	Center to center of tiers, F	
13.	Installed height, H , at mid-length	
14.	Height to bottom of fins, E	
15.	Distance from wall to front of fins, D	
Remarks:		
Manufacturer:		
Date:		

Technician

Reviewed By

Hydronics Institute Section of AHRI	
AHRI FINNED TUBE (COMMERCIAL) RADIATION TEST REPORT DIMENSIONAL DATA SHEET - INSTALLATION IN COVER FORM CFTR-DS3	
Test Number:	Report Number:
Finned Tube Name:	Catalog Designation:
Element Designation:	Room Type:
INSTALLATION IN COVER OR ENCLOSURE (Submit dimensioned cross-section drawing of element in enclosure)	
Construction of Cover or Enclosure	
1. Material of back	
2. Material of front	
3. Material of top	
4. Outlet Type (top A, inclined B or front)	
Details of Tested Unit	
5. Catalog Designation, cover or enclosure	
6. Catalog designation of element	
7. Total length of element, L_t	
8. Active length of element, L_a	
9. Number of tiers	
10. Center to center of tiers, F	
11. Height to bottom of fins, E	
12. Total length of enclosure, L_e	
13. Installed height, H_t , H_f or H_i at mid-length	
14. Depth of enclosure, J	
15. Width of outlet, A, B or C	
16. Inclination of outlet if inclined, α	
17. Length of outlet, L_g	
18. Size of individual outlet section, L_o	
19. Height of inlet, G	
20. Width of inlet opening, K	
Remarks:	
Manufacturer:	
Date:	

Technician

Reviewed By

Hydronics Institute Section of AHRI

CFTR-
TR1

FINNED TUBE RADIATION TEST REPORT (Steam)					
Finned Tube Name:			Catalog Designation:		
Cover or Enclosure:			Type of Test Room:		Warm Wall Booth
1.	Test No.	Unit Under Test	No-Load		
2.	Tested Height (installed) in				
3.	Tested Active Length of Finned Tube ft				
4.	Total Length of Test Unit ft				
5.	Barometric Pressure in Hg or psi				
6.	Steam Supply Temperature (T_{s3}) °F				
7.	Absolute Steam Pressure in Hg or psi				
8.	Saturated Steam Temperature Corresponding to Pressure (T_{s1}) °F				
9.	Superheat (Item 6 - Item 8) °F				
10.	Average Air Temperature (T_a) °F				
11.	Steam Temperature - Average Air Temperature (Item 8 - Item 10) °F				
12.	Duration of Test h				
13.	Total Weight of Condensate during test lb				
14.	Gross Condensation Rate (R_g) (Item 13 ÷ Item 12) lb/h				
15.	Condensation Rate under No-Load Correction (C_{nl}) lb/h				
16.	Net Condensation Rate (Item 14 - Item 15) lb/h				
17.	Latent Heat of Steam (h_{fg}) Btu/lb				
18.	Condensation Capacity at rating conditions, H_c (Item 17 x Item 16 ÷ Item 3) Btu/h-ft				
19.	Correction for Steam and Air Temperature (C_s) (Appendix C, Section C7.5.1, AHRI Standard 1410) Unitless				
20.	Correction for Barometric Pressure (C_b) (Appendix C, Section C7.5.2, AHRI Standard 1410) Unitless				
21.	Condensation Capacity for Standard Rating conditions (H_s) (Appendix C, Section C7.6, AHRI Standard 1410) Btu/h-ft				
Manufacturer					
Report Prepared By		Title		Date	